

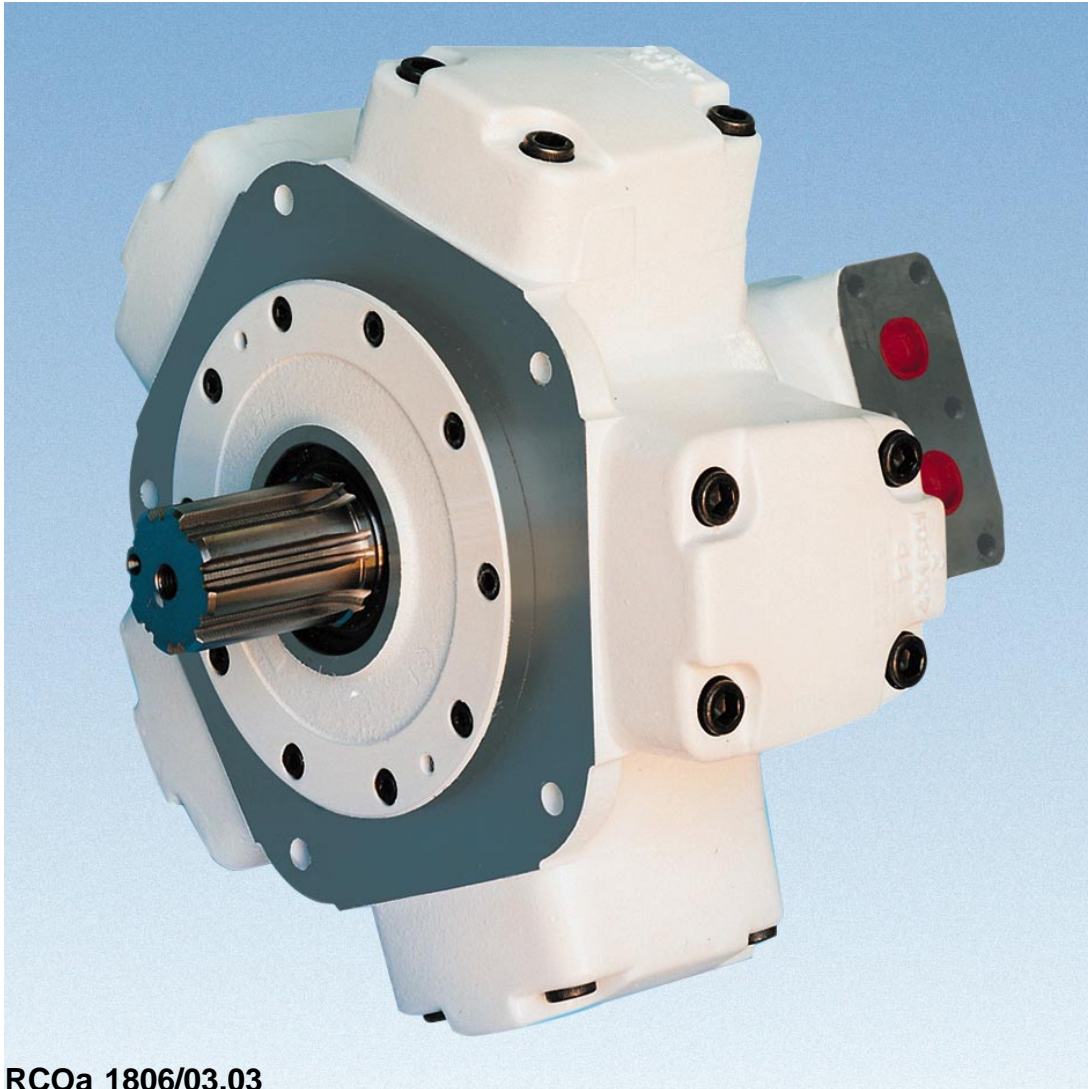

Radial Piston Motor Type MR, MRE



RCOa 1806/03.03

CONTENTS	PAG.
TABLE OF CONTENTS	2
GENERAL CHARACTERISTICS	3
FUNCTIONAL DESCRIPTION	4
TECHNICAL DATA	5
FLUID SELECTION	6
FLUSHING PROCEDURE	7
OPERATING DIAGRAM MOTOR TYPE MR 33 MR 57 MR 73	8
OPERATING DIAGRAM MOTOR TYPE MR 93 MR 110 MR 125	9
OPERATING DIAGRAM MOTOR TYPE MR 160 MR 190 MR 200	10
OPERATING DIAGRAM MOTOR TYPE MR 250 MR 300 MRE 330	11
OPERATING DIAGRAM MOTOR TYPE MR 350 MR 450 MRE 500	12
OPERATING DIAGRAM MOTOR TYPE MR 600 MR 700 MRE 800	13
OPERATING DIAGRAM MOTOR TYPE MR 1100 MRE 1400 MR 1600	14
OPERATING DIAGRAM MOTOR TYPE MR 1800 MRE 2100 MR 2400	15
OPERATING DIAGRAM MOTOR TYPE MR 2800 MRE 3100 MR 3600	16
OPERATING DIAGRAM MOTOR TYPE MR 4500 MRE 5400 MR 6500	17
OPERATING DIAGRAM MOTOR TYPE MR 7000 MRE 8200	18
OPERATING DIAGRAM (RUNNING PRESSURE DIFFERENCE AT NOLOAD)	19-20
OPERATING DIAGRAM (MOTOR/PUMP: BOOST PRESSURE)	20-21
RADIAL LOAD	22
BEARING LIFE	23
MOTOR DIMENSIONS	24-25
SHAFT END DIMENSIONS	26-27
COMPONENTS FOR SPEED CONTROL	28-29
PIPE CONNECTION FLANGES	30
COUPLINGS - KEY ADAPTERS	31
HOLDING BRAKE - UNIT DIMENSIONS - TECHNICAL DATA	32-33
INSTALLATION NOTES	34
ORDERING CODE	35
SALES AND SERVICE LOCATIONS WORLDWIDE	36

GENERAL CHARACTERISTICS

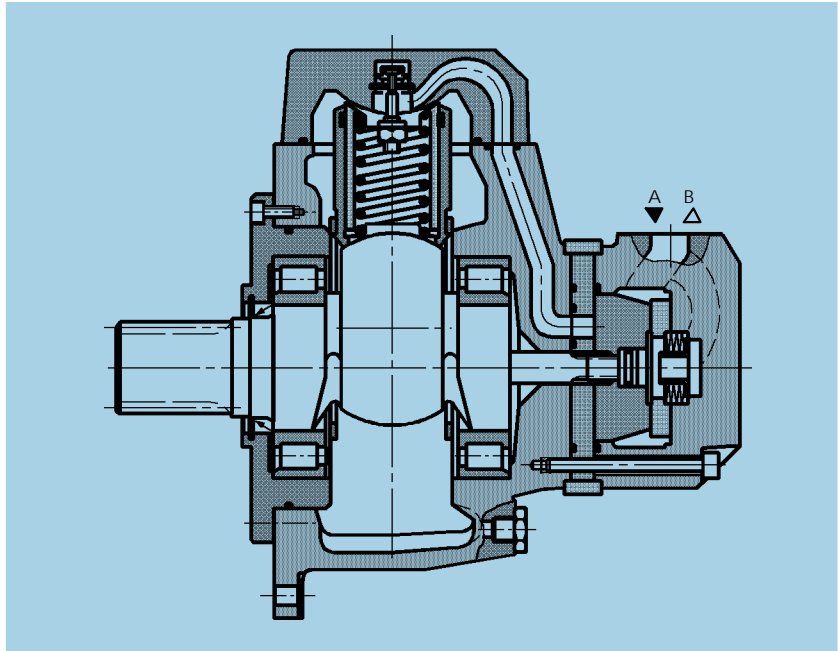

CONSTRUCTION	Fixed displacement radial piston motor
TYPE	MR ; MRE
MOUNTING	Front flange mounting
CONNECTION	Connection flange
MOUNTING POSITION	Any (please note the installation notes on page 34)
BEARING LIFE, RADIAL LOAD	See page 22 and 23
DIRECTION OF ROTATION	Clockwise, anti-clockwise - reversible
FLUID	HLP mineral oils to DIN 51 524 part 2; Fluid type HFB, HFC and Bio-fluids on enquiry. FPM seals are required with phosphorous acid-Ester (HFD)
FLUID TEMPERATURE RANGE	$t \text{ } ^\circ\text{F} - 22^\circ \text{ a } + 176^\circ (-30^\circ \text{ a } +80^\circ \text{ C})$
VISCOSITY RANGE ¹⁾	$v = 85 \text{ to } 4635 \text{ SUS (18 to } 1000 \text{ mm}^2\text{/s)}$; Recommended operating range 141 to 230 SUS (30 to 50 mm ² /s) (see fluid selection on page 6)
FLUID CLEANLINESS	Maximum permissible degree of contamination of fluid NAS 1638 Class 9. We therefore recommend a filter with a minimum retention rate of $\beta_{10} \geq 75$. To ensure a long life we recommend class 8 to NAS 1638. This can be achieved with a filter, with a minimum retention rate of $\beta_5 \geq 100$.

1) For different valves of viscosity please contact PARKER Calzoni

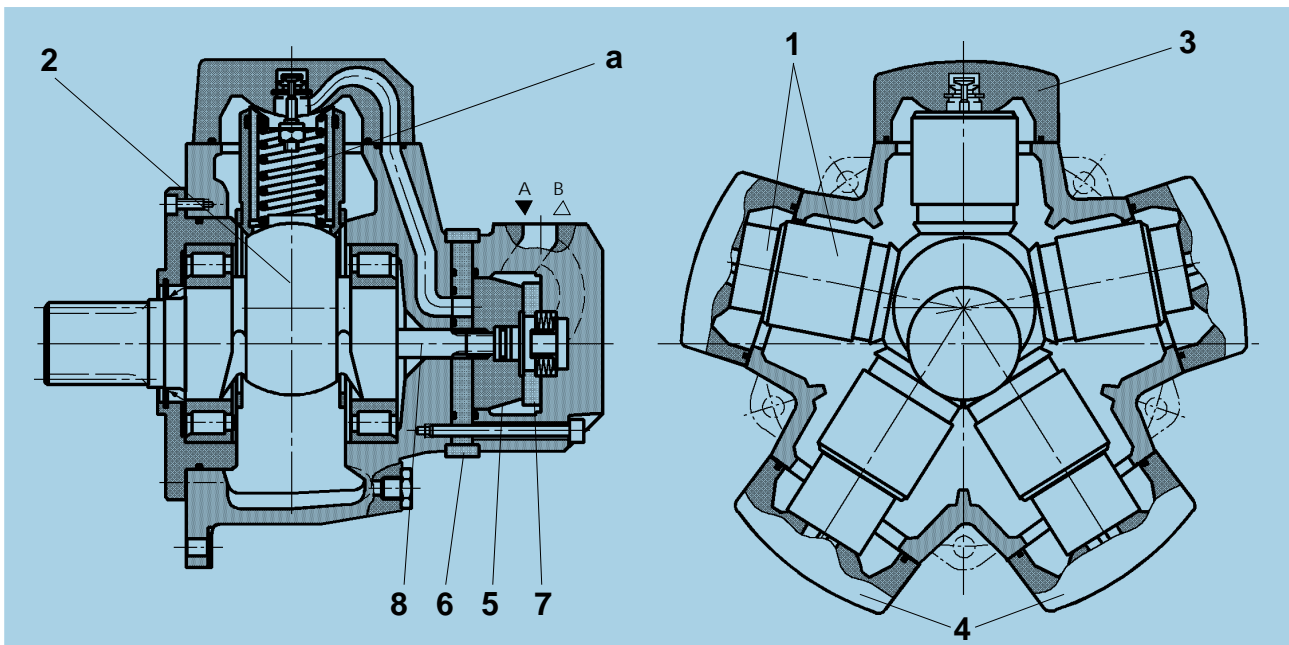

FUNCTIONAL DESCRIPTION

The outstanding performance of this motor is the result of an original and patented design. The principle is to transmit the effort from the stator to the rotating shaft (2) by means of a pressurized column of oil (a) instead of the more common connecting rods, pistons, pads and pins.

This oil column is contained by a telescopic cylinder (1) with a mechanical connection at the lips at each end which seal against the spherical surfaces of the cylinder-heads (3) and the spherical surface of the rotating shaft (4).

These lips retain their circular cross section when stressed by the pressure so there is no alteration in the sealing geometry. The particular selection of materials and optimisation of design has minimized both the friction and the leakage.

Another advantage of this design stems from the elimination of any connecting rods, the cylinder can only expand and retract linearly so there are no transverse components of the thrust. This means no oval wear on the moving parts and no side forces on the cylinder joints.

A consequence of this novel design is a significant reduction in weight and overall size compared with other motors of the same capacity.

TIMING SYSTEM

The timing system is realized by means of a rotary valve (5) driven by the rotary valve driving shaft (8) that it is connected to the rotating shaft.

The rotary valve rotates between the rotary valve plate (6) and the reaction ring (7) which are fixed with the motor's housing. This timing system is also of a patented design being pressure balanced and self compensating for thermal expansion.

EFFICIENCY

The advantages of this type of valve coupled with a revolutionary cylinder arrangement produce a motor with extremely high values of mechanical and volumetric efficiency. The torque output is smooth even at very low speed and the motor gives a high performance starting under load.

TECHINICAL DATA - MOTOR TYPE MR - MRE

Size Motor version	Displacement	Moment inertia of rotating parts	Theoretical specific torque	Min. start. torque / Theoretical torque	Maximum Pressure					Speed range		Maximum output power		Weight	
					input			A+B *	Drain	flushing		flushing			
					cont.	int.	peak			without	with	without	with		
					V	J		%	p	p	p	p	p		n
in ³	lb.in ²	lb.ft/psi		psi	psi	psi	psi	psi	rpm	rpm	Hp	Hp	lb		
M R	33	1.96	1.48	0.025	90	3626	4351	6092	5802	72.5 (218 psi with "F1" shaft seal)	1-1400	1-1400	8.9	13.4	66.14
	57	3.44	1.59	0.046	90						1-1300	1-1300	14.8	22.8	66.14
	73	4.43	4.79	0.061	90						1-1200	1-1200	20.2	26.8	83.78
	93	5.65	5.16	0.076	90						1-1150	1-1150	22.8	33.5	83.78
	110	6.65	5.53	0.087	90						1-1100	1-1100	24.1	37.6	83.78
	125	7.61	19.44	0.102	90						1-900	1-900	22.8	33.5	101.4
	160	9.75	19.65	0.129	90						1-900	1-900	26.8	40.2	101.4
	190	11.69	19.89	0.155	90						1-850	1-850	32.2	48.3	101.4
	200	12.16	19.56	0.163	90						1-800	1-800	33.5	51.0	110.2
	250	15.31	20.78	0.203	90						1-800	1-800	42.9	64.4	110.2
	300	18.56	22.36	0.244	90						1-750	1-750	46.9	71.1	110.2
	350	21.33	77.19	0.283	90						1-640	1-640	55.0	83.1	169.8
	450	27.56	78.53	0.366	90						1-600	1-600	61.7	100.6	169.8
	600	37.10	90.58	0.493	90						1-520	1-520	75.1	112.6	213.8
	700	43.09	122.47	0.575	90						1-500	1-500	87.2	130.1	213.8
	1100	68.7	154.28	0.910	90						0.5-330	0.5-330	103.3	159.6	308.6
	1600	97.5	227.73	1.292	90						0.5-260	0.5-260	128.7	193.1	460.8
	1800	110.4	291.86	1.465	90						0.5-250	0.5-250	138.1	205.2	460.8
	2400	139.9	968.89	1.937	90						0.5-220	0.5-220	160.9	245.4	716.5
	2800	170.4	1016.83	2.263	90						0.5-215	0.5-215	170.3	260.2	716.5
3600	221.9	1657.78	2.944	90	0.5-150	0.5-180	164.9	248.1	1120						
4500	274.8	1713.72	3.346	91	0.5-130	0.5-170	187.7	281.6	1120						
6500	394.2	3887.52	5.267	91	0.5-110	0.5-130	221.3	321.8	1764						
7000	408.7	3887.52	5.665	91	0.5-100	0.5-130	228	335.3	1764						
M R E	330	20.28	22.38	0.270	90	3046	3626	5076	5802	72.5 (218 psi with "F1" shaft seal)	1-750	1-750	42.9	65.7	110.2
	500	30.38	78.53	0.403	90						1-600	1-600	61.7	93.9	169.8
	800	49.08	122.47	0.651	90						1-450	1-450	87.2	124.7	213.8
	1400	83.6	154.28	1.109	92						0.5-280	0.5-280	103.3	136.8	319.7
	2100	127.6	291.86	1.693	91						0.5-250	0.5-250	134.1	198.5	487.2
	3100	189.4	1016.83	2.512	91						0.5-215	0.5-215	167.6	254.8	725.3
	5400	329.6	1713.72	4.374	92						0.5-120	0.5-160	187.7	281.6	1129
	8200	502	3887.52	6.657	92						0.5-90	0.5-120	228	335.3	1786

LARGER DISPLACEMENTS ARE AVAILABLE IN THE MRT - MRTE - MRTF MOTOR SERIES

(*) Please contact PARKER Calzoni

EXAMPLE: At a certain ambient temperature, the operating temperature in the circuit is 122°F (50°C). In the optimum operating viscosity range (v_{rec} ; shaded section), this corresponds to viscosity grades VG 46 or VG 68; VG 68 should be selected.

IMPORTANT: The drain oil temperature is influenced by pressure and speed and is usually higher than the circuit temperature or the tank temperature. At no point in the system, however, may the temperature be higher than 176°F (80°C).

If the optimum conditions cannot be met due to the extreme operating parameters or high ambient temperature, we always recommend flushing the motor case in order to operate within the viscosity limits.

Should it be absolutely necessary to use a viscosity beyond the recommended range, you should first contact PARKER Calzoni for confirmation.

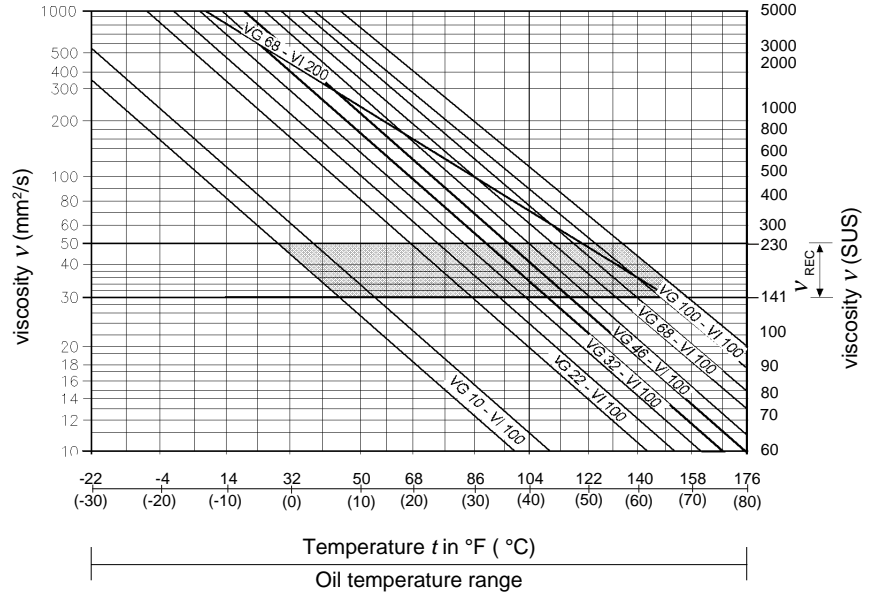

GENERAL NOTES

More detailed information regarding the choice of the fluid can be requested to PARKER Calzoni. Further notes on installation and commissioning can be found on page 34 of this data sheet. When operating with HF pressure fluids or bio-degradable pressure fluids possible limitations of the technical data must be taken into consideration, please see information sheet TCS 85, or consult PARKER Calzoni.

OPERATING VISCOSITY RANGE

The viscosity, quality and cleanliness of operating fluids are decisive factors in determining the reliability, performance and life-time of an hydraulic component. The maximum life-time and performance are achieved within the recommended viscosity range. For applications that go beyond this range, we recommend to contact PARKER Calzoni.

$$v_{rec} = \text{recommended operating viscosity } 141 \dots 230 \text{ SUS } (30 \dots 50 \text{ mm}^2/\text{s})$$

This viscosity refers to the temperature of the fluid entering the motor, and at the same time to the temperature inside the motor housing (case temperature). We recommend to select the viscosity of the fluid based on the maximum operating temperature, to remain within the recommended viscosity range. To reach the value of maximum continuous power the operating viscosity should be within the recommended viscosity range of 30 - 50 cSt.

LIMITS OF VISCOSITY RANGE

For limit conditions the following is valid:

- $v_{min.abs.} = 45 \text{ SUS } (10 \text{ mm}^2/\text{s})$ in emergency, short term
- $v_{min.} = 85 \text{ SUS } (18 \text{ mm}^2/\text{s})$ for continuous operation at reduced performances
- $v_{max.} = 4635 \text{ SUS } (1000 \text{ mm}^2/\text{s})$ short term upon cold start

CHOOSING THE TYPE OF FLUID ACCORDING TO THE OPERATING TEMPERATURE

The operating temperature of the motor is defined as the greater temperature between that of the incoming fluid and that of the fluid inside the motor housing (case temperature). We recommend that you choose the viscosity of the fluid based on the maximum operating temperature, to remain within the recommended viscosity range (see diagram). We recommend that the higher viscosity grade must be selected in each case.

FILTRATION

The motor life also depends on the fluid filtration. At least it must correspond to one of the following cleanliness.

- class 9 according to NAS 1638
- class 6 according to SAE, ASTM, AIA
- class 18/15 according to ISO/DIS 4406

In order to assure a longer life a cleanliness class 8 to NAS 1638 is recommended, achieved with a filter of $\beta_s=100$. In case the above mentioned classes can not be achieved, please consult us.

CASE DRAIN PRESSURE

The lower the speed and the case drain pressure, the longer the life of the shaft seal. The maximum permissible housing pressure is

$$p_{max} = 72.5 \text{ psi}$$

If the case drain pressure is higher than 72.5 psi it is possible to use a special 218 psi shaft seal (see page 35, Seals, Code "F1").

"FPM" SEALS

In case of operating conditions with high oil temperature or high ambient temperature, we recommend to use "FPM" seals (see page 35, Seals, Code "V1"). These "FPM" seals should be used with HFD fluids.

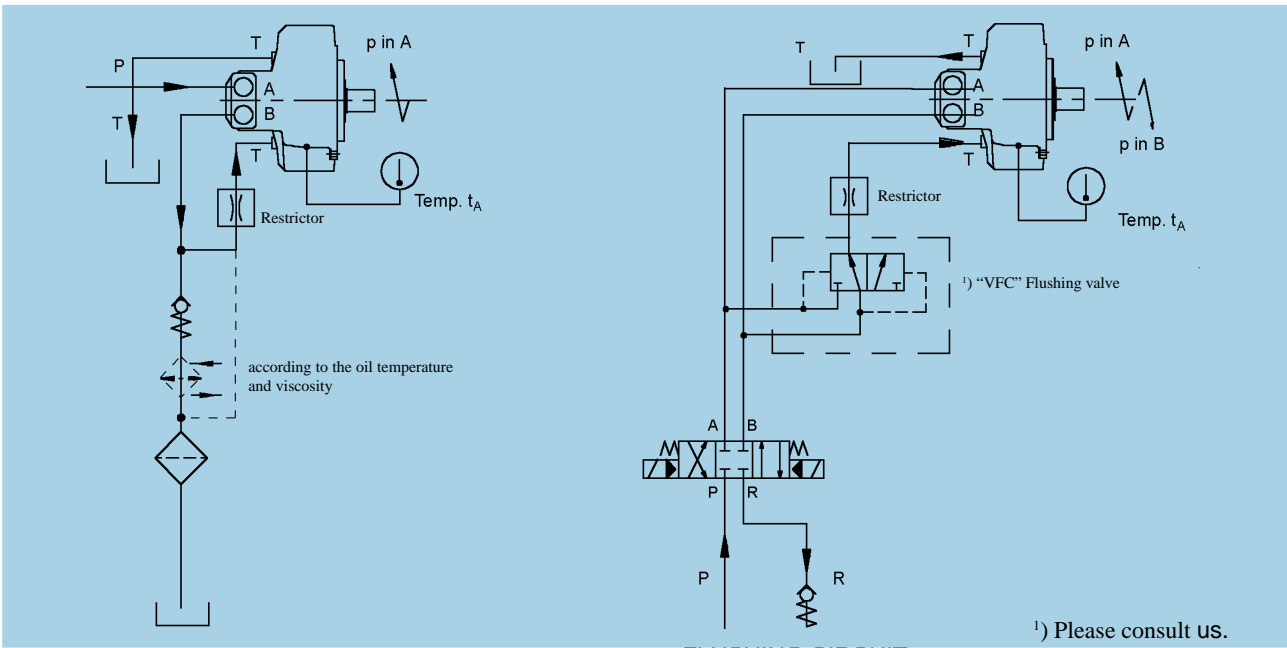

FLUSHING CIRCUIT (MONO-DIRECTIONAL ROTATION)

FLUSHING CIRCUIT (BI-DIRECTIONAL ROTATION)

¹⁾ Please consult us.

FLUSHING

The motor case must be flushed when the continuous operating performances of the motor are inside the "Continuous operating area with flushing" (see Operating Diagram from page 8 to page 18), in order to assure the minimum oil viscosity inside the motor case of 141 SUS (30 mm²/s) (see page 6 - Fluid Selection). The flushing can be necessary also when the operating performances are outside the "Continuous operating area with flushing", but the system is not able to assure the minimum viscosity conditions requested by the motor as specified at page 6.

NOTE1:

The oil temperature inside the motor case is obtainable by adding 5° F (3°C) to the motor surface temperature (t_A , see figures).

NOTE2:

With the standard shaft seal the maximum drain case pressure is 72.5 psi. For the selection of the restrictor, please consult us.

FLOW

TYPE	MOTOR VERSION	FLUSHING FLOW
MR	33, 57, 73, 93, 110	Q = 1.3 gpm
MR - MRE	125, 160, 190, 200, 250, 300, 330	Q = 1.6 gpm
MR - MRE	350, 450, 500	Q = 2.0 gpm
MR - MRE	600, 700, 800, 1100, 1400	Q = 2.5 gpm
MR - MRE	1600, 1800, 2100	Q = 4.0 gpm
MR - MRE	2400, 2800, 3100, 3600, 4500, 5400, 6500, 7000, 8200	Q = 5.3 gpm

OPERATING DIAGRAM

(average values) measured at $V = 167 \text{ SUS}$ ($36 \text{ mm}^2/\text{s}$); $t = 113^\circ\text{F}$ (45°C);

$p_{\text{outlet}} = 0 \text{ psi}$ (0 bar)

- 1 Output power
- 2 Intermittent operating area
- 3 Continuous operating area with flushing
- 4 Continuous operating area
- 5 Inlet pressure
- η_t Total efficiency
- η_v Volumeter efficiency

MR 33

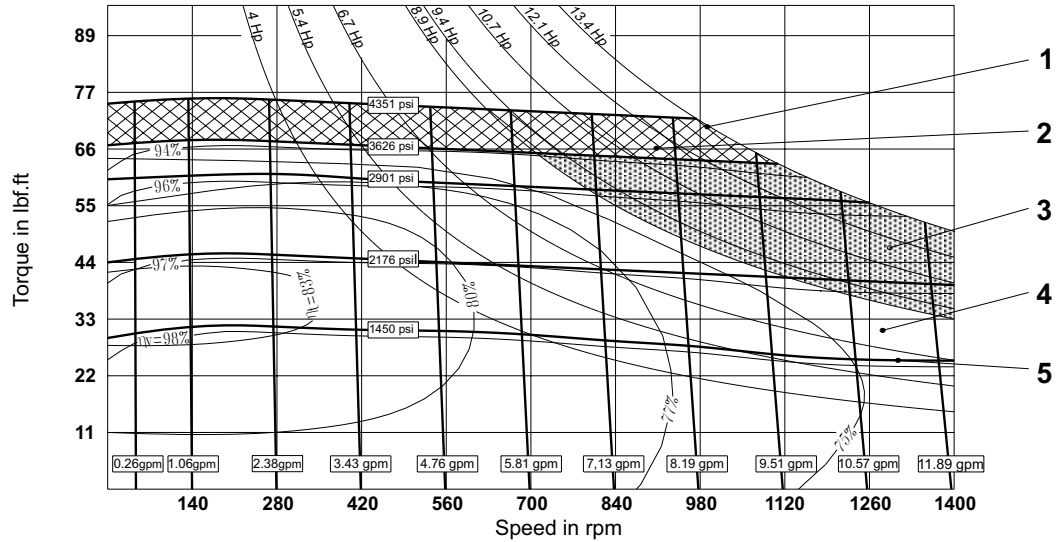

MR 57

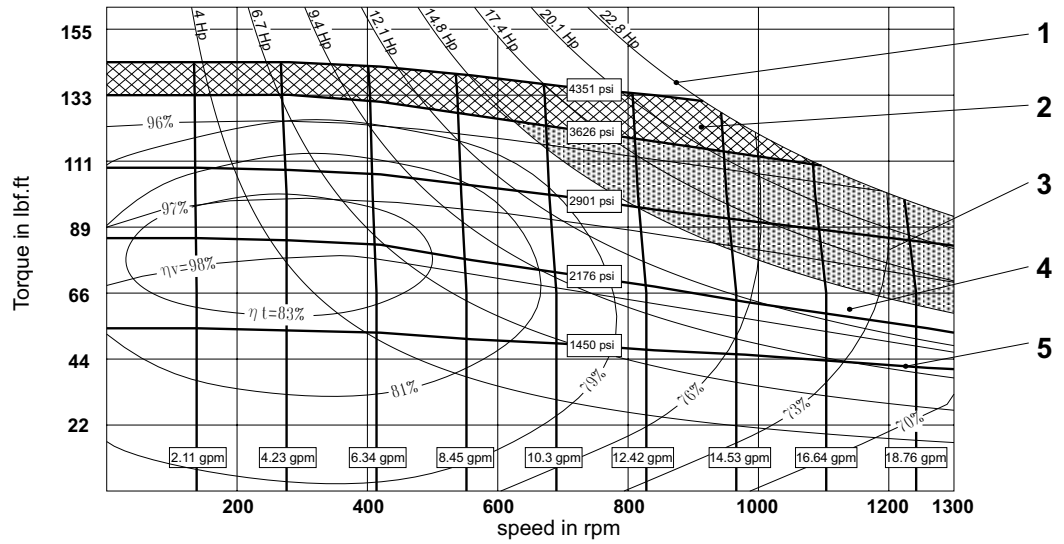

MR 73

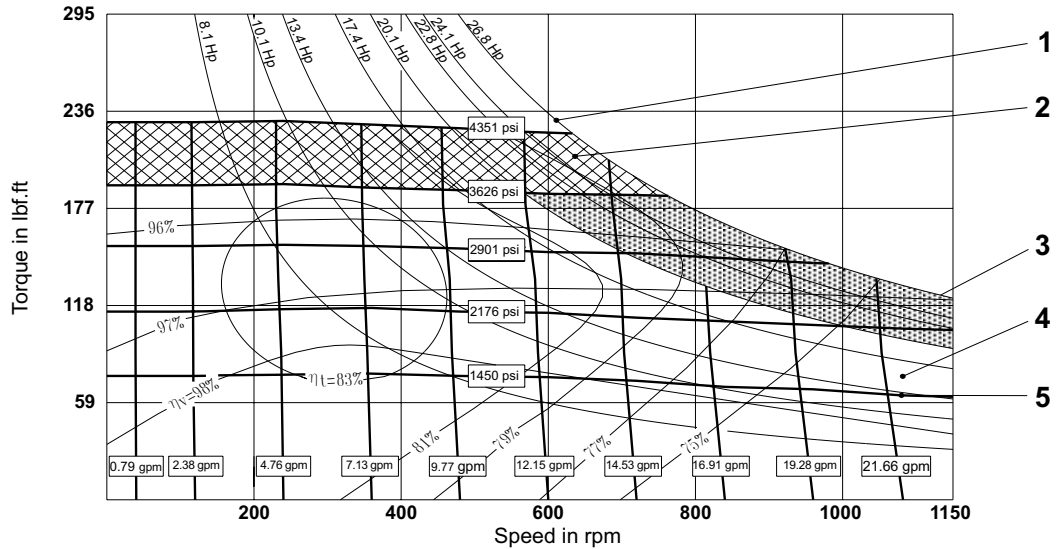

OPERATING DIAGRAM

(average values) measured at $V = 167 \text{ SUS}$ ($36 \text{ mm}^2/\text{s}$); $t = 113^\circ\text{F}$ (45°C);

$p_{\text{outlet}} = 0 \text{ psi}$ (0 bar)

- 1 Output power
- 2 Intermittent operating area
- 3 Continuous operating area with flushing
- 4 Continuous operating area
- 5 Inlet pressure
- η_t Total efficiency
- η_v Volumeter efficiency

MR 93

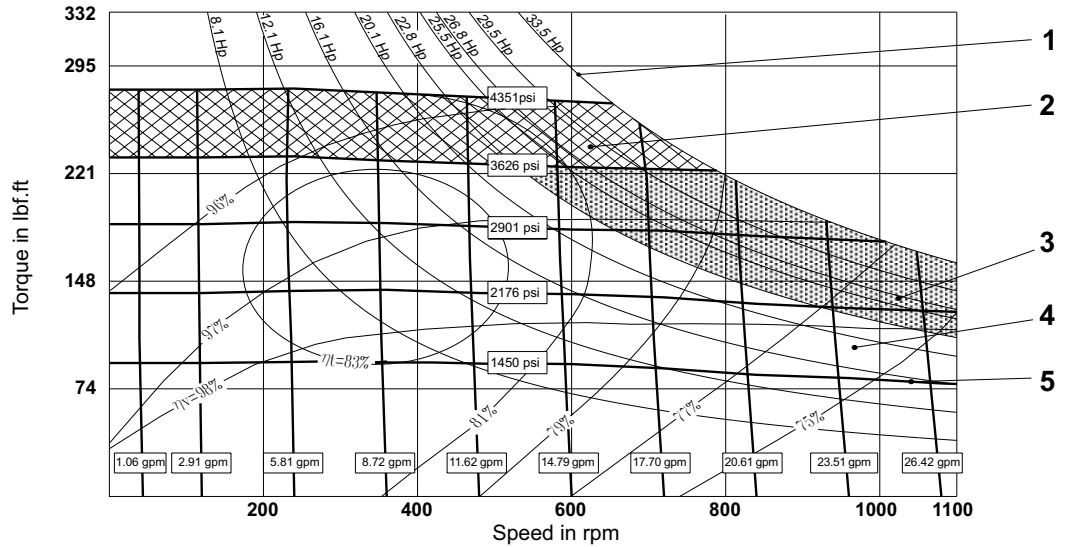

MR 110

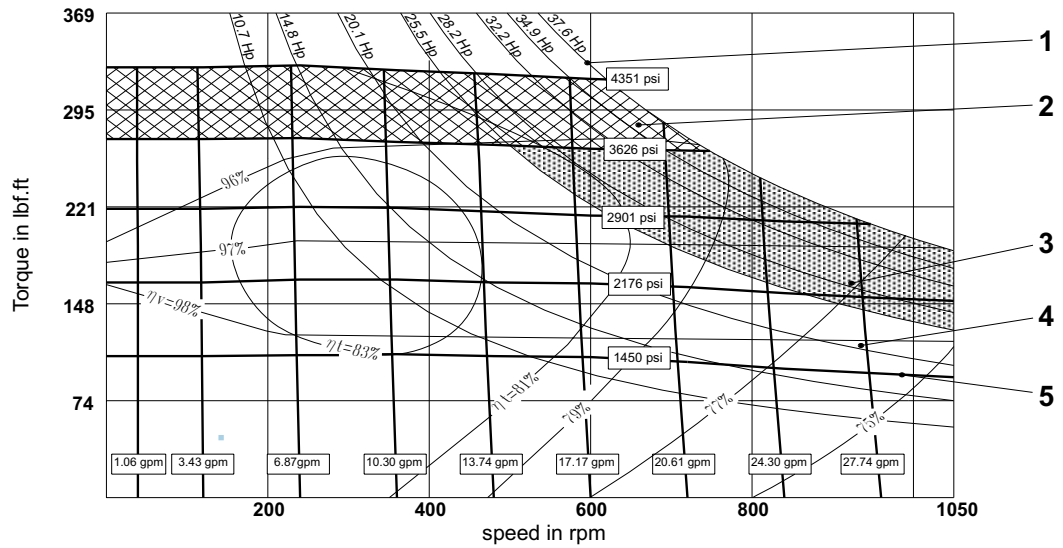

MR 125

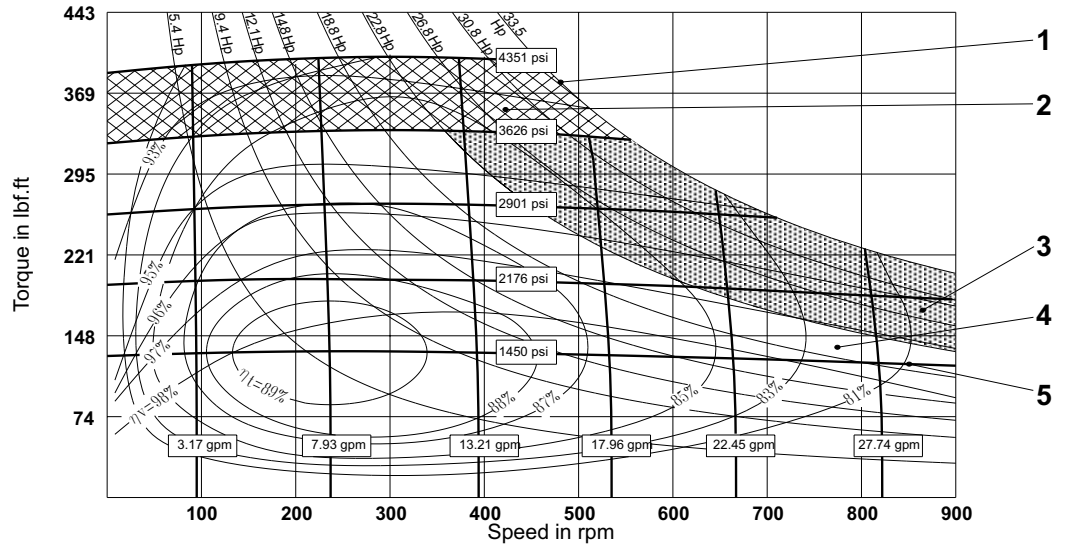

OPERATING DIAGRAM

(average values) measured at $V = 167 \text{ SUS}$ ($36 \text{ mm}^2/\text{s}$); $t = 113^\circ\text{F}$ (45°C);

$p_{\text{outlet}} = 0 \text{ psi}$ (0 bar)

- 1 Output power
- 2 Intermittent operating area
- 3 Continuous operating area with flushing
- 4 Continuous operating area
- 5 Inlet pressure
- η_t Total efficiency
- η_v Volumeter efficiency

MR 160

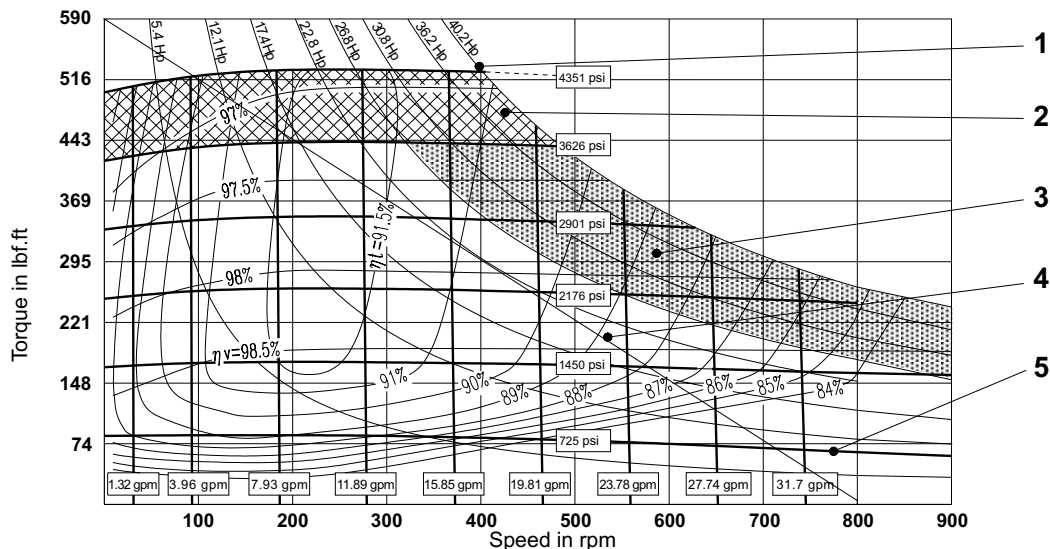

MR 190

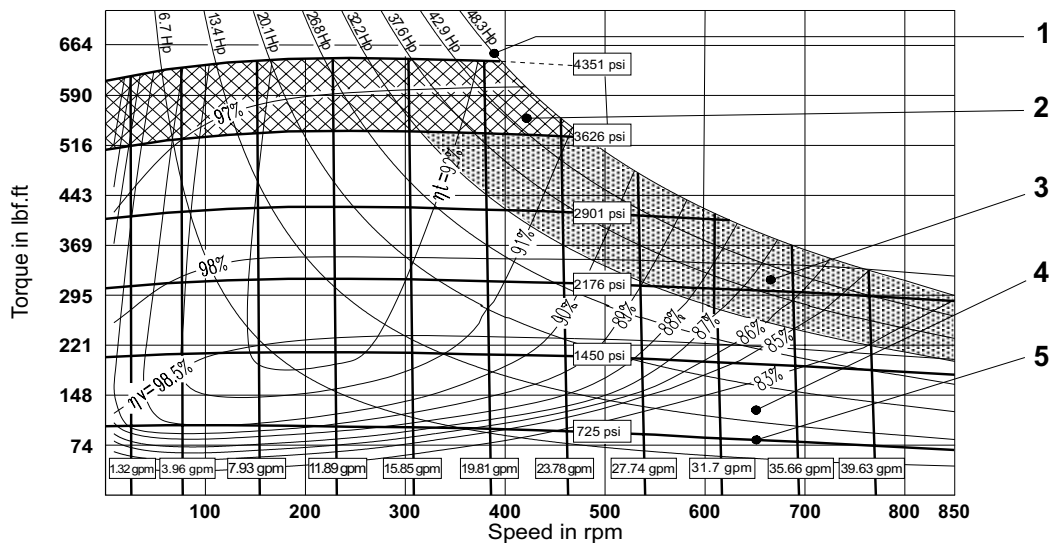

MR 200

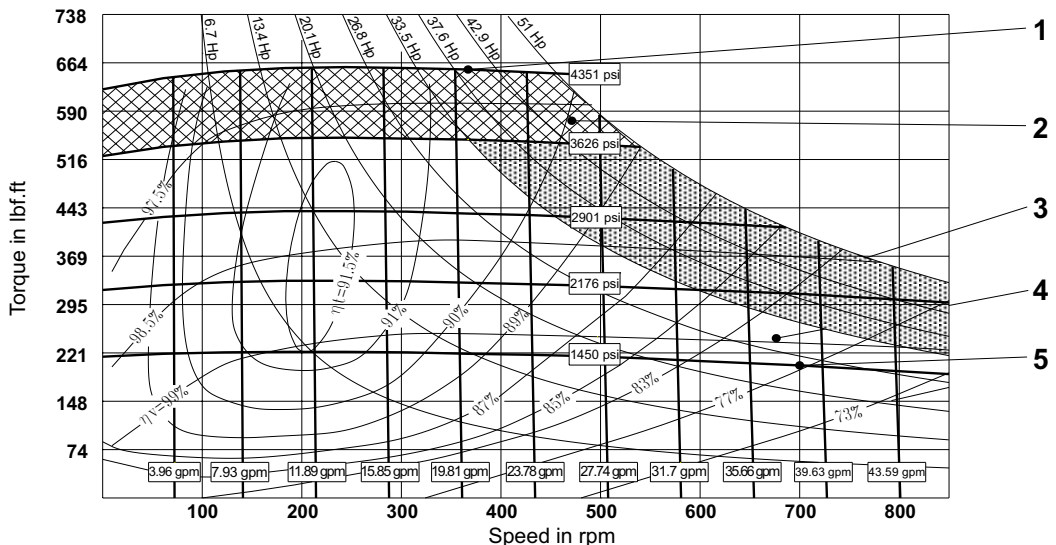

OPERATING DIAGRAM - MOTOR TYPE MR - MRE

OPERATING DIAGRAM

(average values) measured at $V = 167 \text{ SUS}$ ($36 \text{ mm}^2/\text{s}$); $t = 113^\circ\text{F}$ (45°C);

$p_{\text{outlet}} = 0 \text{ psi}$ (0 bar)

- 1 Output power
- 2 Intermittent operating area
- 3 Continuous operating area with flushing
- 4 Continuous operating area
- 5 Inlet pressure
- η_t Total efficiency
- η_v Volumeter efficiency

MR 250

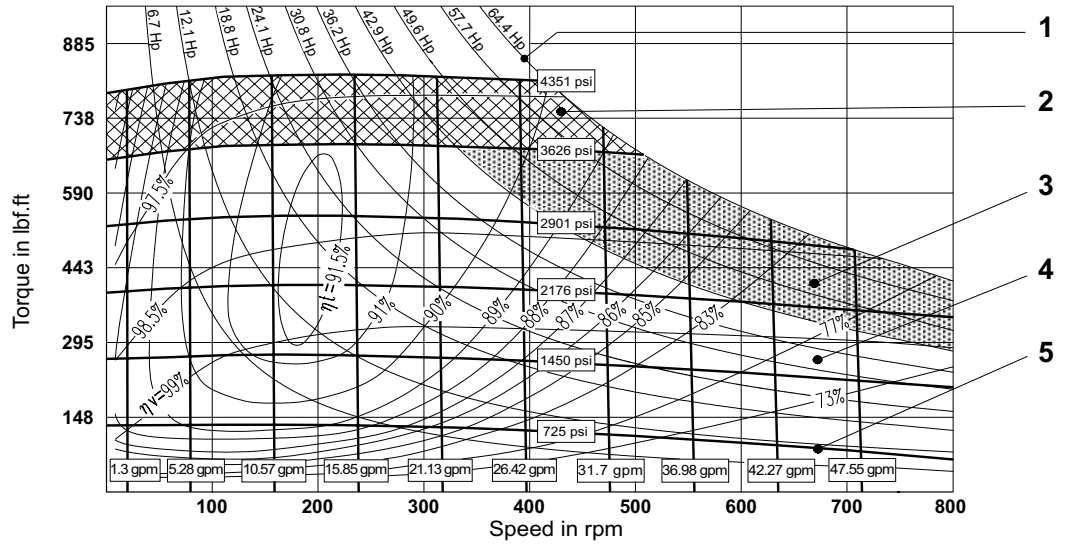

MR 300

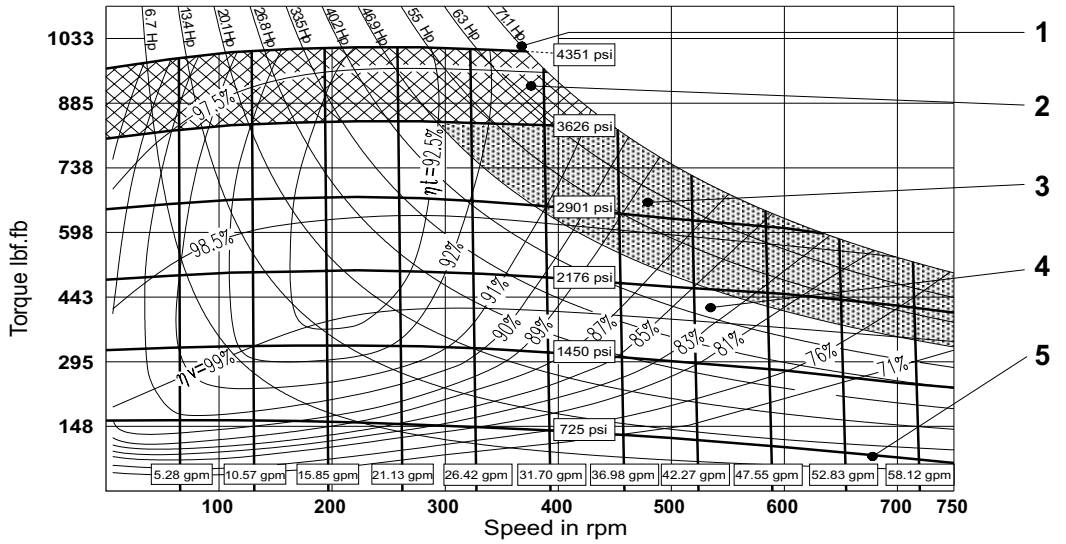

MRE 330

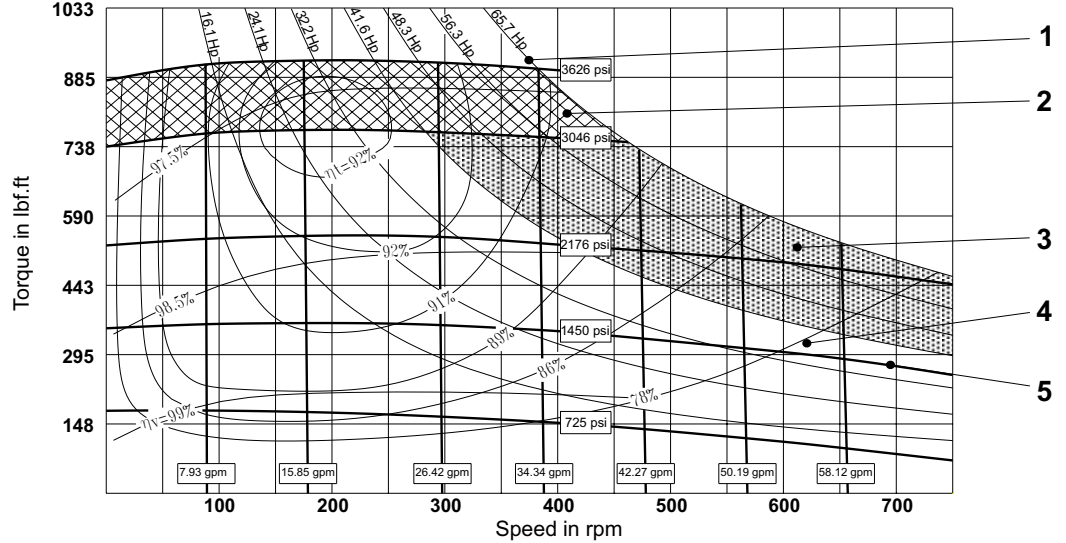

OPERATING DIAGRAM - MOTOR TYPE MR - MRE

OPERATING DIAGRAM

(average values) measured at $V = 167 \text{ SUS}$ ($36 \text{ mm}^2/\text{s}$); $t = 113^\circ\text{F}$ (45°C);

$$p_{\text{outlet}} = 0 \text{ psi (0 bar)}$$

- 1 Output power
- 2 Intermittent operating area
- 3 Continuous operating area with flushing
- 4 Continuous operating area
- 5 Inlet pressure
- η_t Total efficiency
- η_v Volumeter efficiency

MR 350

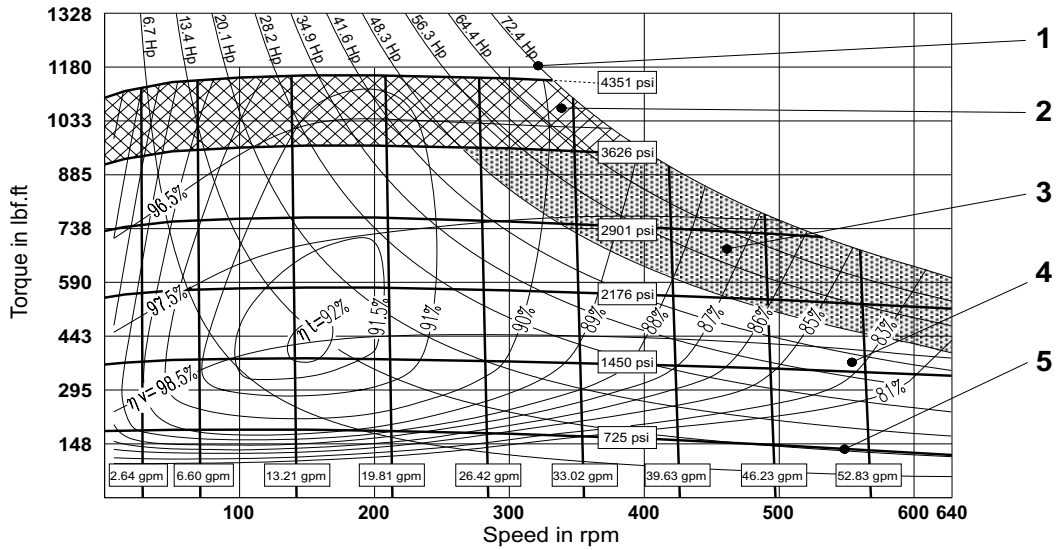

MR 450

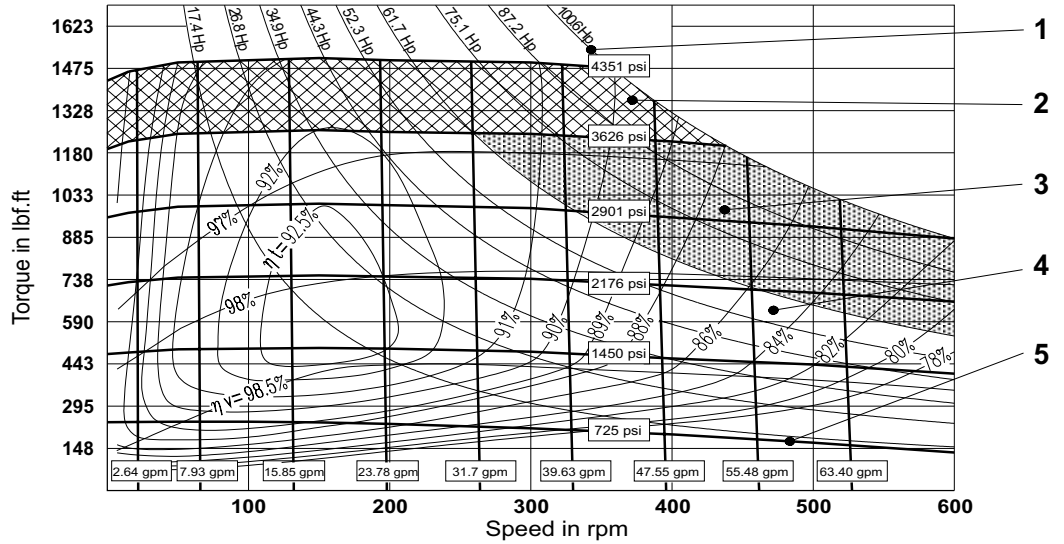

MRE 500

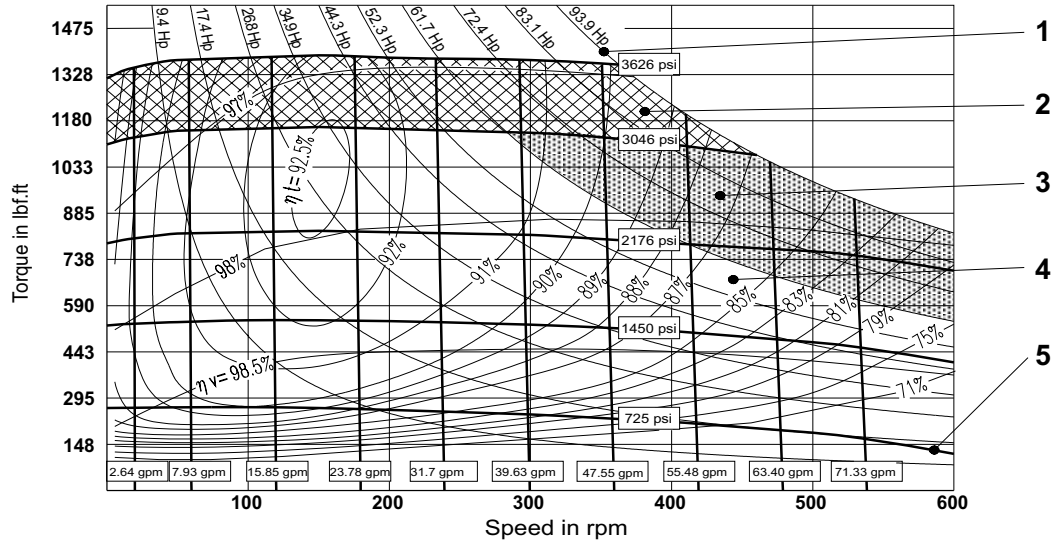

OPERATING DIAGRAM

(average values) measured at $V = 167 \text{ SUS}$ ($36 \text{ mm}^2/\text{s}$); $t = 113^\circ\text{F}$ (45°C);

$p_{\text{outlet}} = 0 \text{ psi}$ (0 bar)

- 1 Output power
- 2 Intermittent operating area
- 3 Continuous operating area with flushing
- 4 Continuous operating area
- 5 Inlet pressure
- η_t Total efficiency
- η_v Volumeter efficiency

MR 600

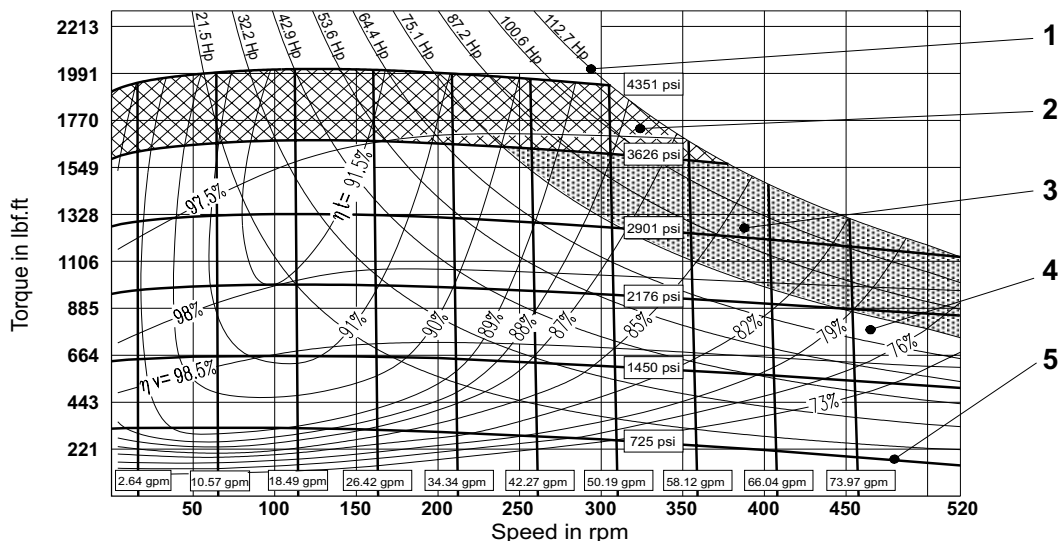

MR 700

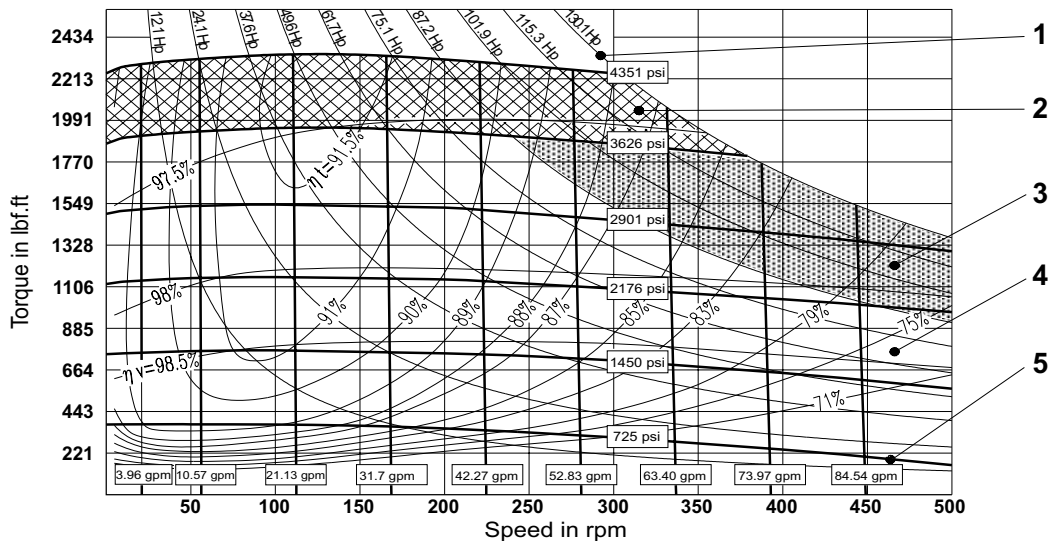

MRE 800

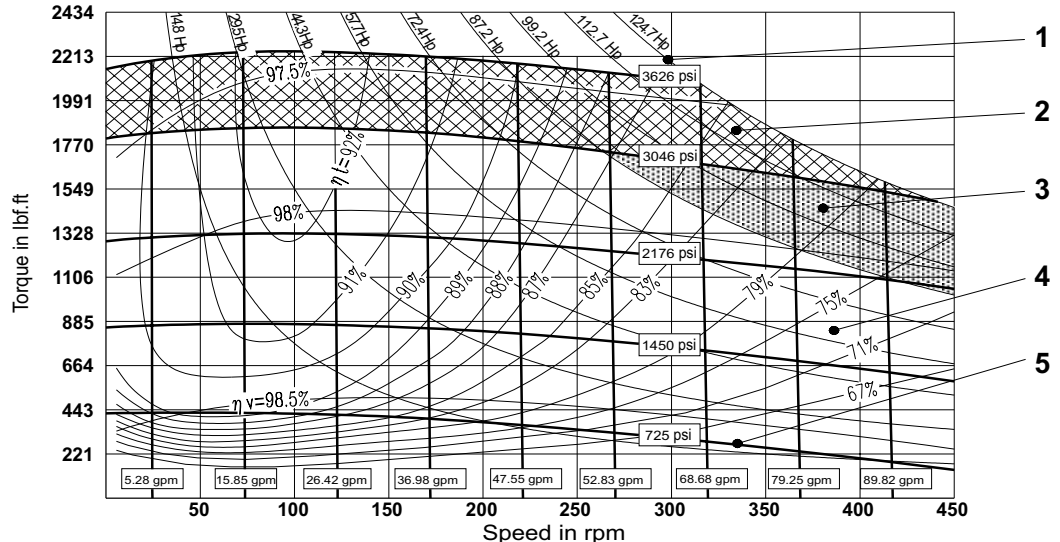

OPERATING DIAGRAM - MOTOR TYPE MR - MRE

OPERATING DIAGRAM

(average values) measured at $V = 167 \text{ SUS}$ ($36 \text{ mm}^2/\text{s}$); $t = 113^\circ\text{F}$ (45°C);

$p_{\text{outlet}} = 0 \text{ psi}$ (0 bar)

- 1 Output power
- 2 Intermittent operating area
- 3 Continuous operating area with flushing
- 4 Continuous operating area
- 5 Inlet pressure
- η_t Total efficiency
- η_v Volumeter efficiency

MR 1100

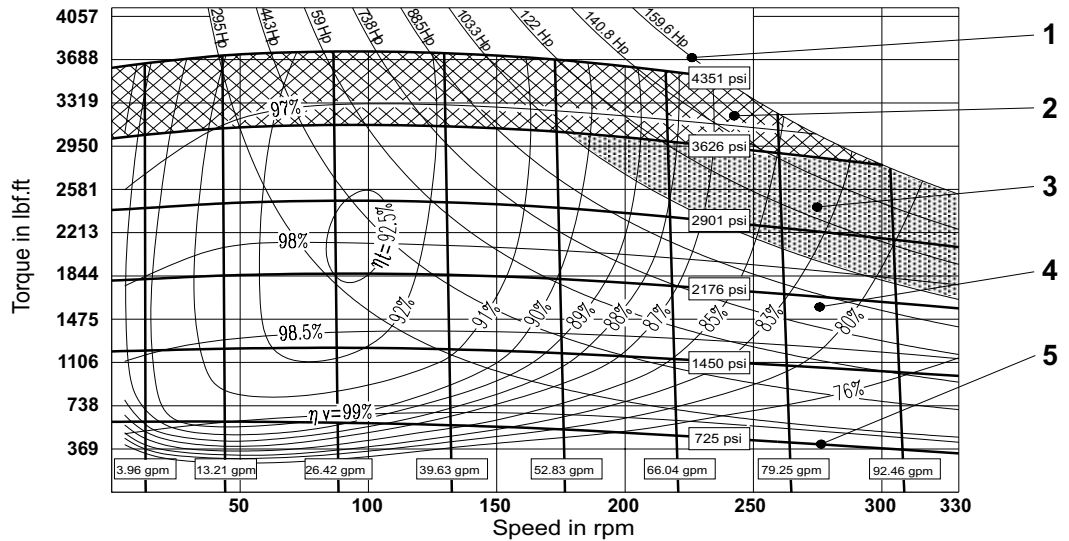

MRE 1400

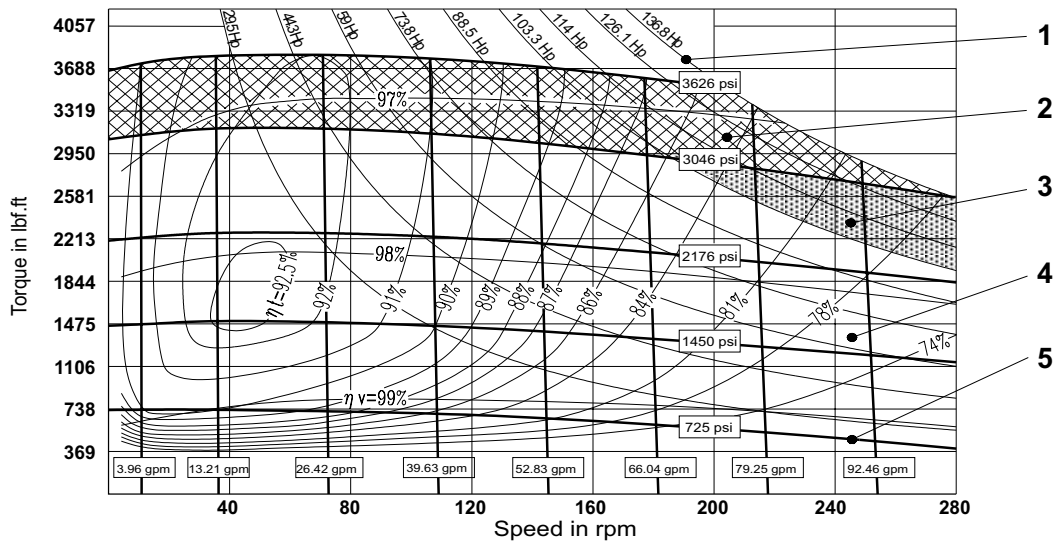

MR 1600

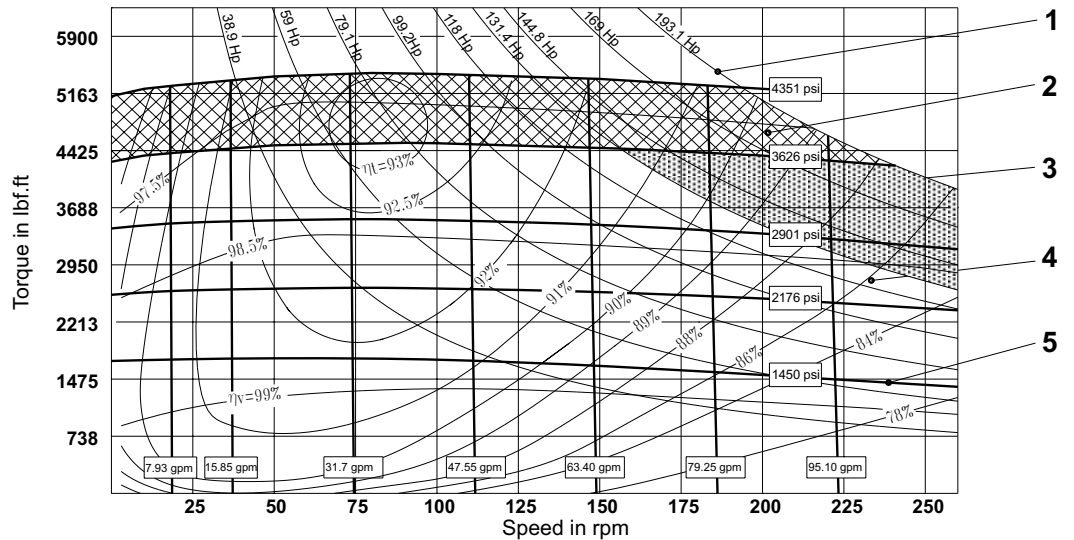

OPERATING DIAGRAM

(average values) measured at $V = 167 \text{ SUS}$ ($36 \text{ mm}^2/\text{s}$); $t = 113^\circ\text{F}$ (45°C);

$p_{\text{outlet}} = 0 \text{ psi}$ (0 bar)

- 1 Output power
- 2 Intermittent operating area
- 3 Continuous operating area with flushing
- 4 Continuous operating area
- 5 Inlet pressure
- η_t Total efficiency
- η_v Volumeter efficiency

MR 1800

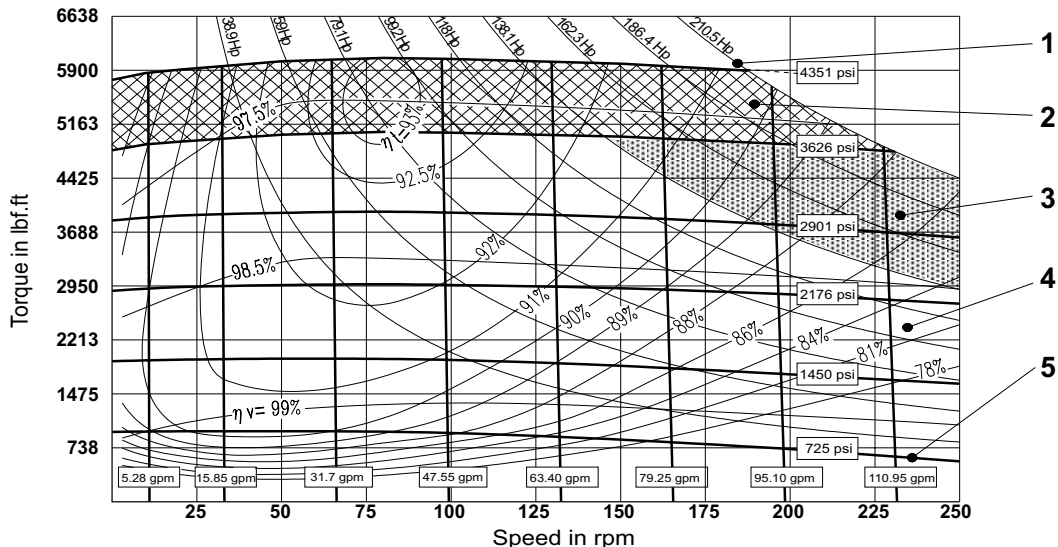

MRE 2100

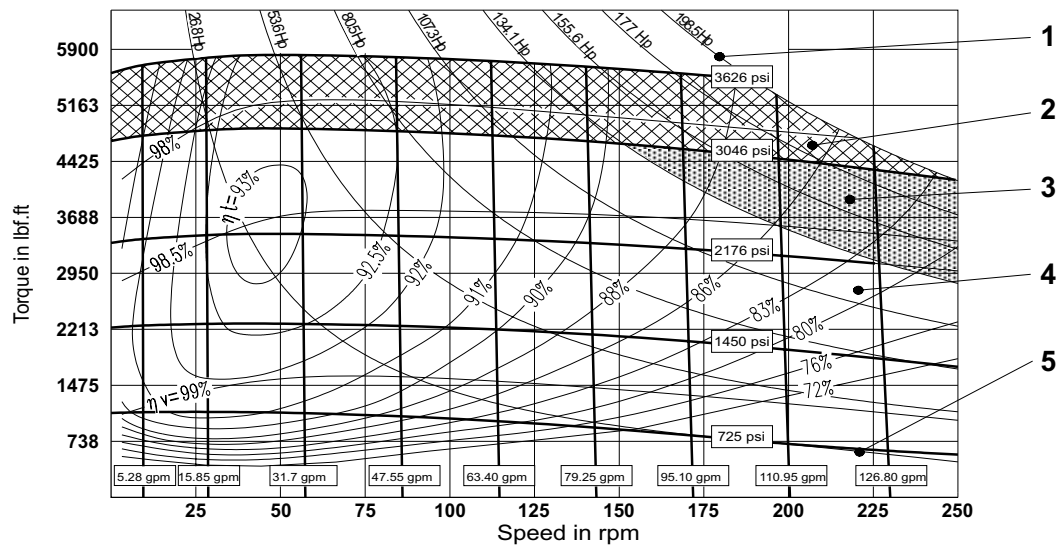

MR 2400

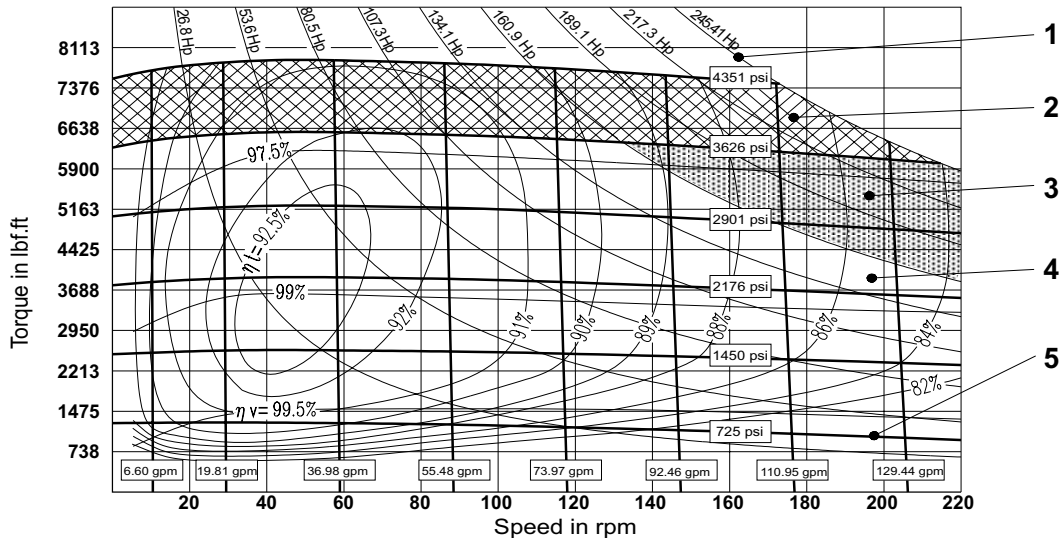

OPERATING DIAGRAM - MOTOR TYPE MR - MRE

OPERATING DIAGRAM

(average values) measured at $V = 167 \text{ SUS}$ ($36 \text{ mm}^2/\text{s}$); $t = 113^\circ\text{F}$ (45°C);

$p_{\text{outlet}} = 0 \text{ psi}$ (0 bar)

- 1 Output power
- 2 Intermittent operating area
- 3 Continuous operating area with flushing
- 4 Continuous operating area
- 5 Inlet pressure
- η_t Total efficiency
- η_v Volumeter efficiency

MR 2800

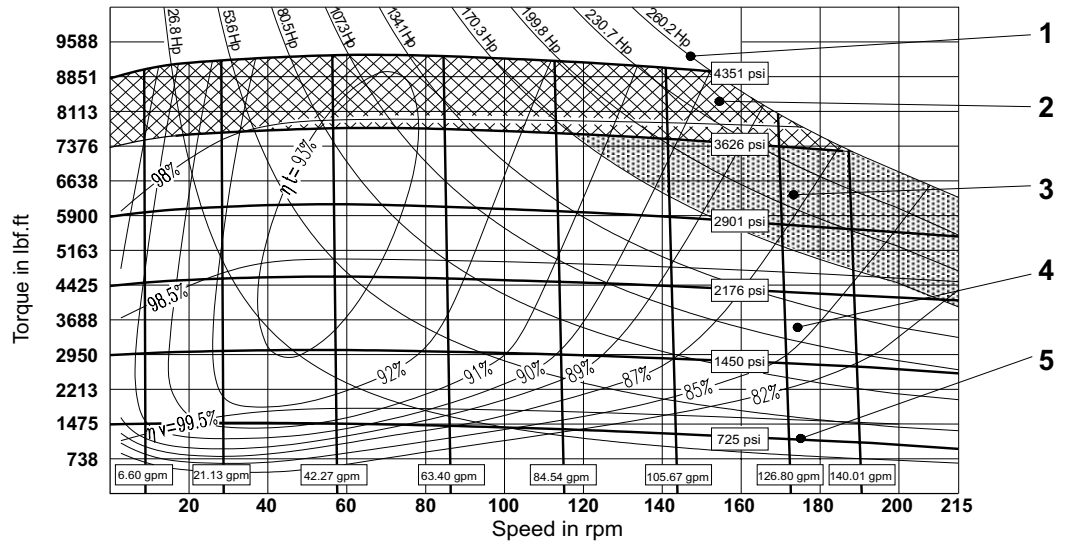

MRE 3100

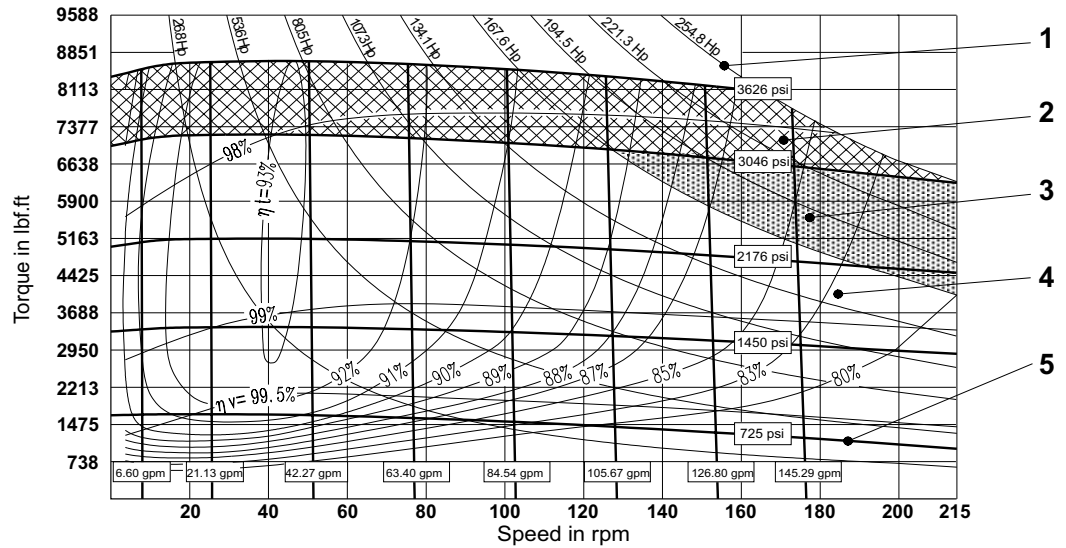

MR 3600

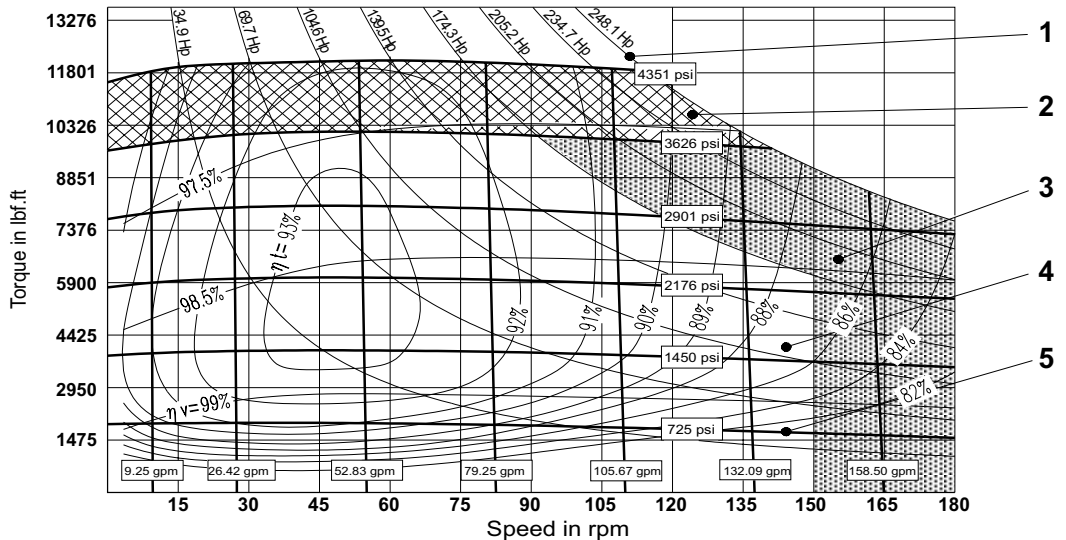

OPERATING DIAGRAM

(average values) measured at $V = 167 \text{ SUS}$ ($36 \text{ mm}^2/\text{s}$); $t = 113^\circ\text{F}$ (45°C);

$p_{\text{outlet}} = 0 \text{ psi}$ (0 bar)

- 1 Output power
- 2 Intermittent operating area
- 3 Continuous operating area with flushing
- 4 Continuous operating area
- 5 Inlet pressure
- η_t Total efficiency
- η_v Volumeter efficiency

MR 4500

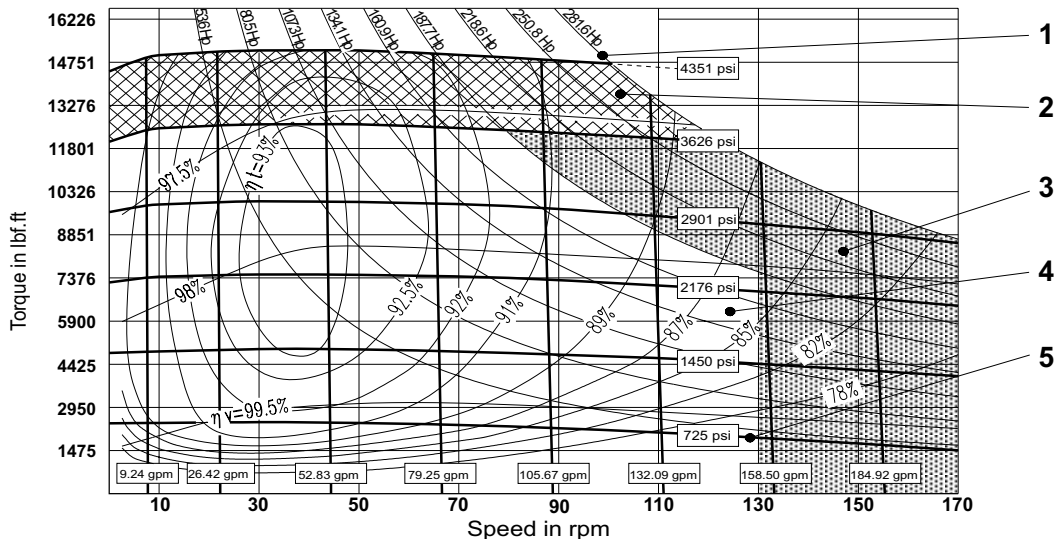

MRE 5400

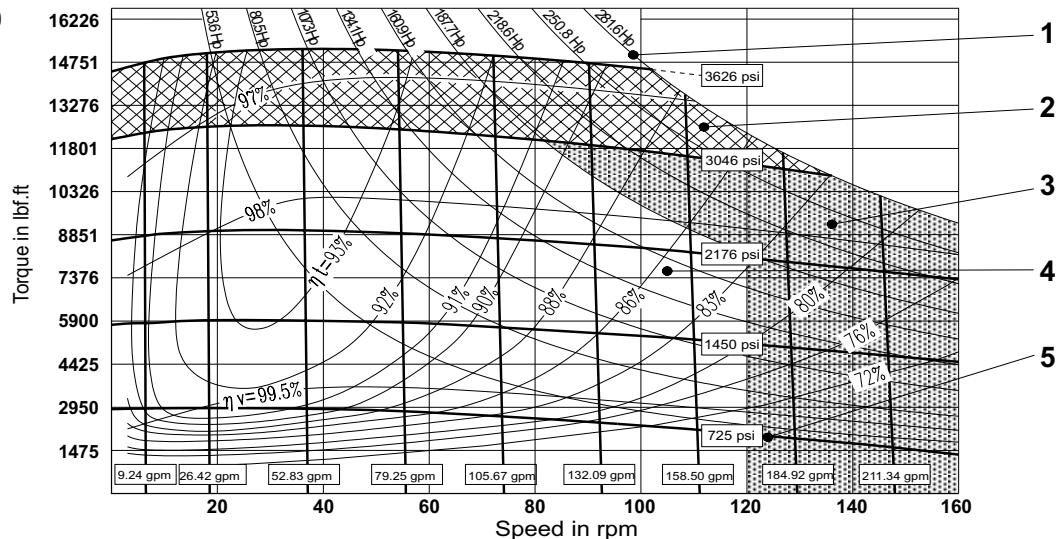

MR 6500

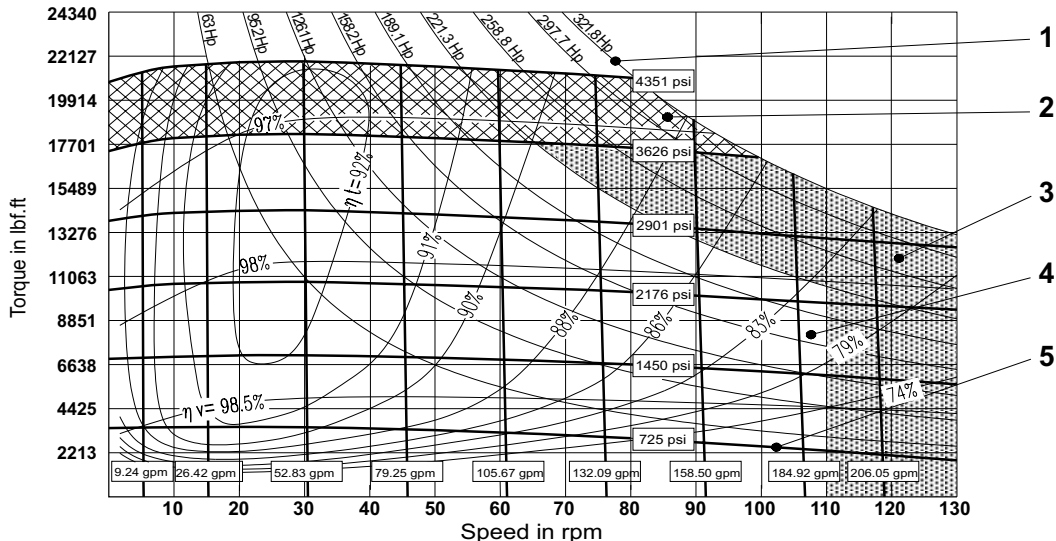

OPERATING DIAGRAM - MOTOR TYPE MR - MRE

OPERATING DIAGRAM

(average values) measured at $V = 167 \text{ SUS}$ ($36 \text{ mm}^2/\text{s}$); $t = 113^\circ\text{F}$ (45°C);

$p_{\text{outlet}} = 0 \text{ psi}$ (0 bar)

- 1 Output power
- 2 Intermittent operating area
- 3 Continuous operating area with flushing
- 4 Continuous operating area
- 5 Inlet pressure
- η_t Total efficiency
- η_v Volumeter efficiency

MR 7000

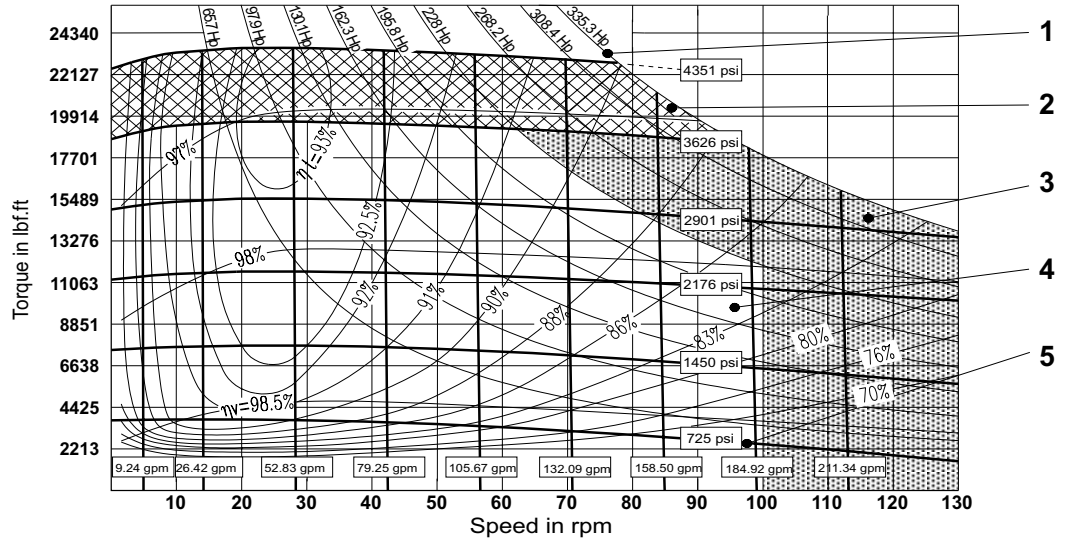

MRE 8200

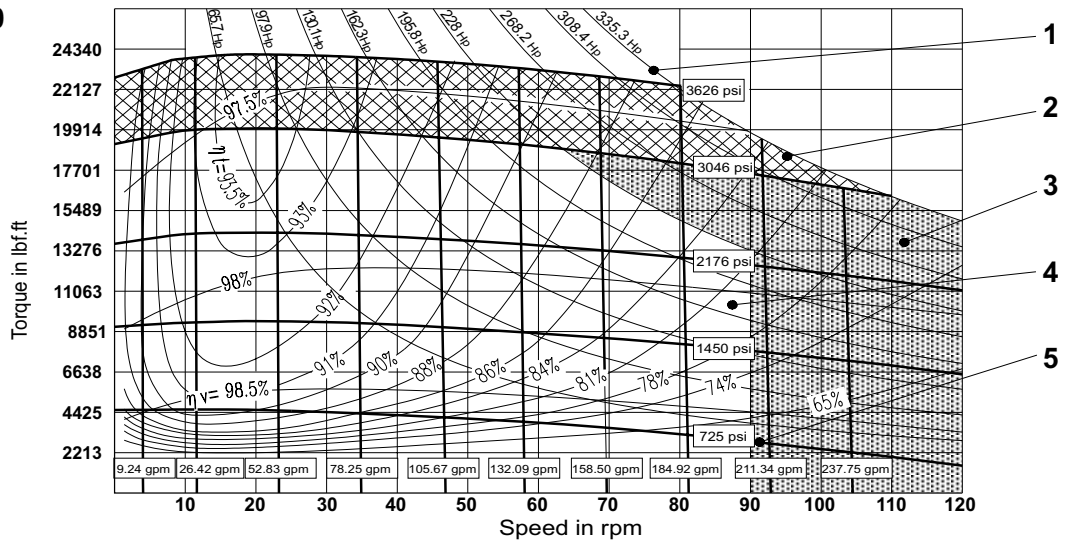

OPERATING DIAGRAM

(average values) measured at $V = 167 \text{ SUS (36 mm}^2\text{/s)}$; $t = 113^\circ\text{F (45}^\circ\text{C)}$;

Min. required pressure difference Δp with idling speed (shaft unloaded)

$p_{\text{outlet}} = 0 \text{ psi (0 bar)}$

MR
33 - 110

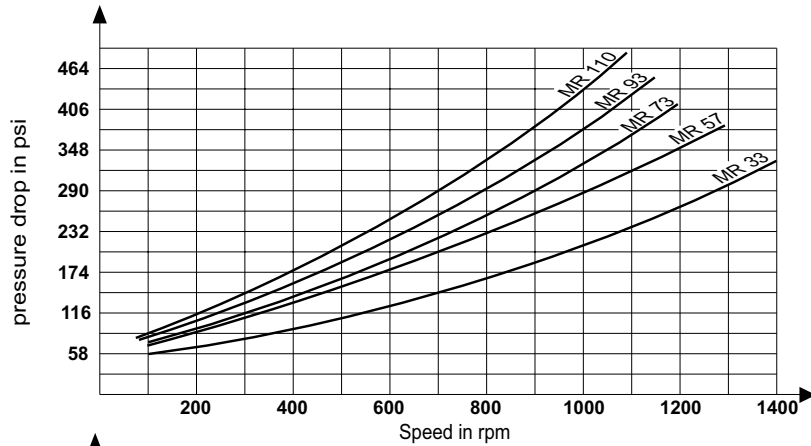

MR - MRE
125 - 330

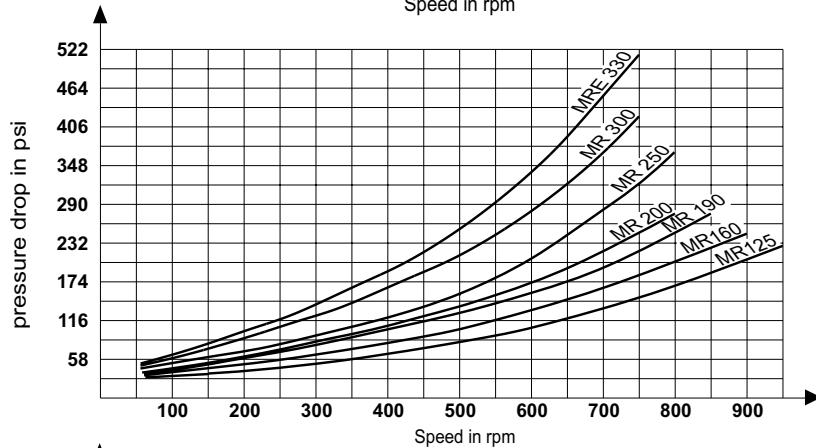

MR - MRE
350 - 800

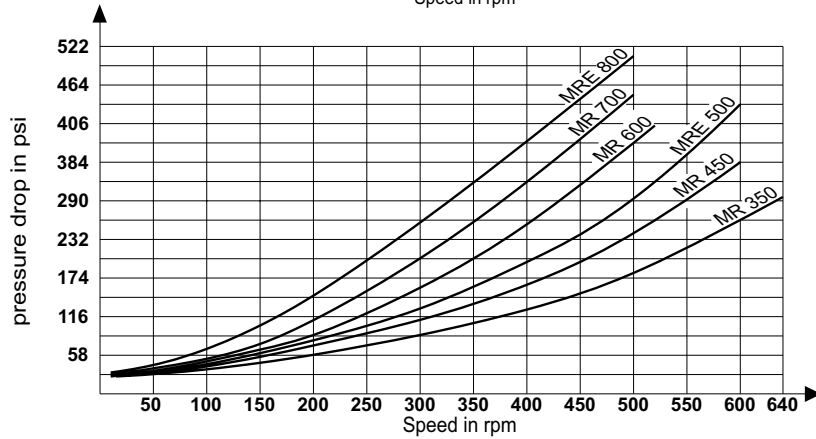

MR - MRE
1100 - 2100

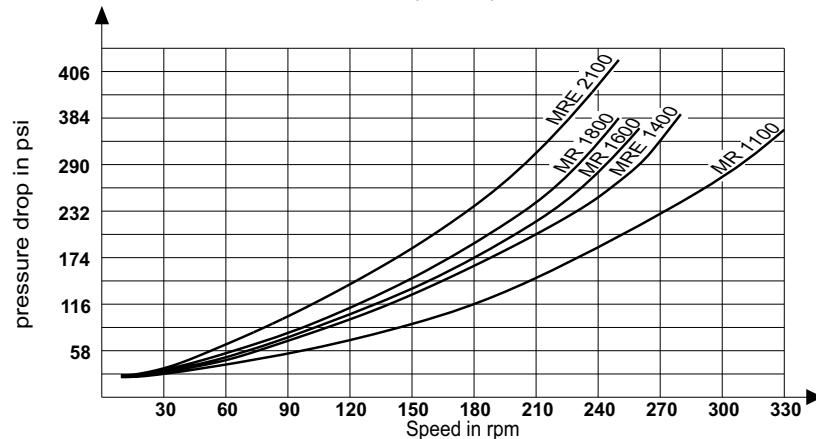

OPERATING DIAGRAM

(average values) measured at $V = 167 \text{ SUS (36 mm}^2\text{/s)}$; $t = 113^\circ\text{F (45}^\circ\text{C)}$;

Min. required pressure difference Δp with idling speed (shaft unloaded)

$p_{\text{outlet}} = 0 \text{ psi (0 bar)}$

**MR - MRE
2400 - 8200**

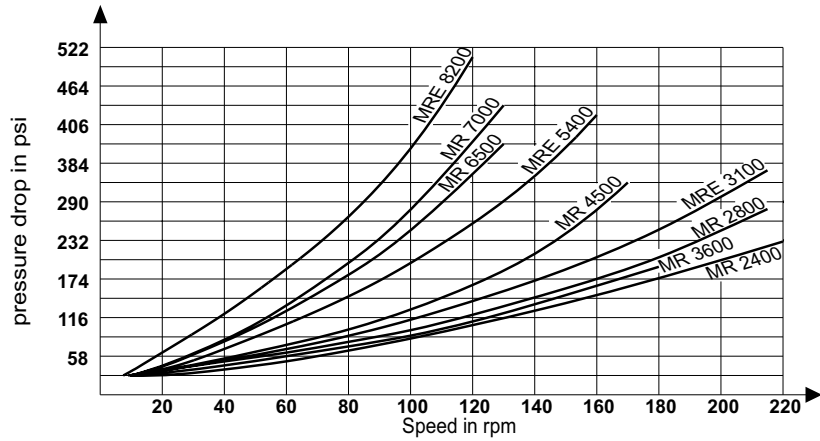

Minimum boost pressure during pump operation

**MR
33 - 110**

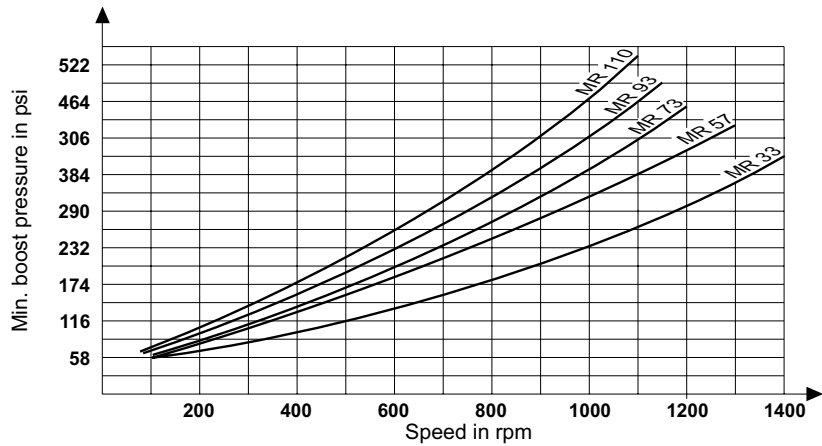

**MR - MRE
125 - 330**

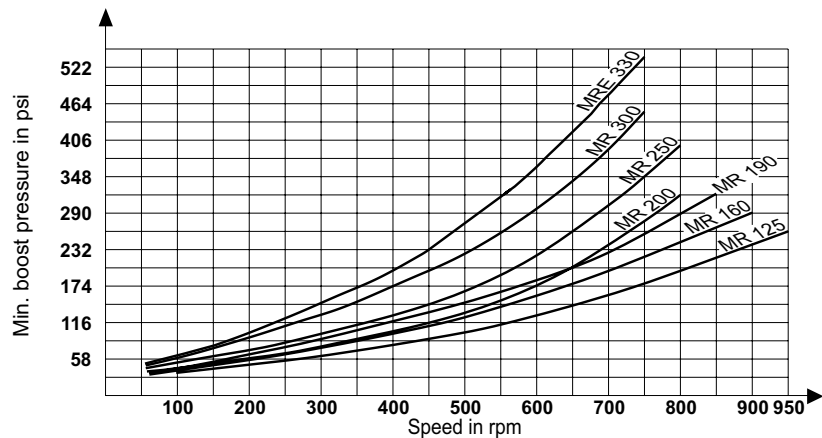

OPERATING DIAGRAM

(average values) measured at $V = 167 \text{ SUS}$ ($36 \text{ mm}^2/\text{s}$); $t = 113^\circ\text{F}$ (45°C);

Minimum boost pressure during pump operation

$p_{\text{outlet}} = 0 \text{ psi}$ (0 bar)

**MR - MRE
350 - 800**

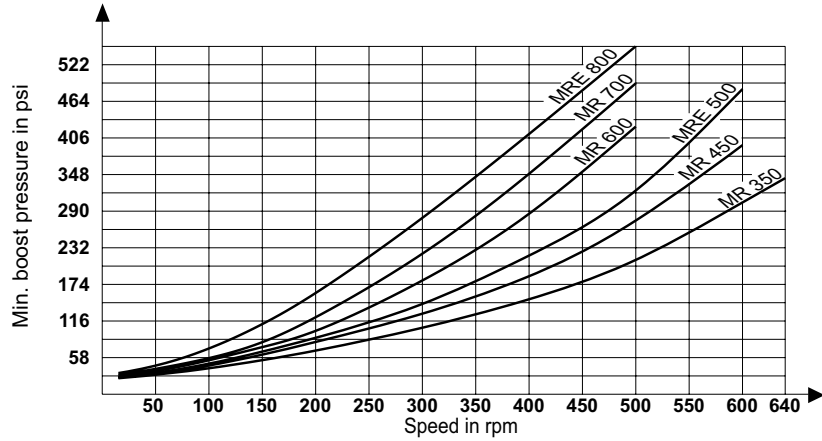

**MR - MRE
1100 - 2100**

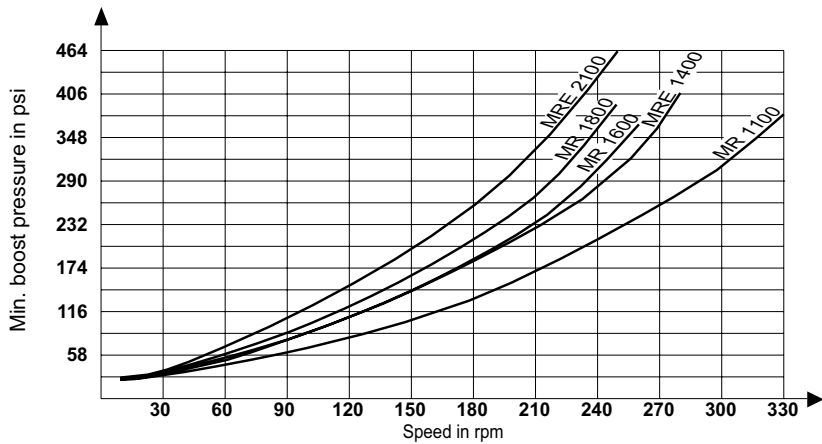

**MR - MRE
2400 - 8200**

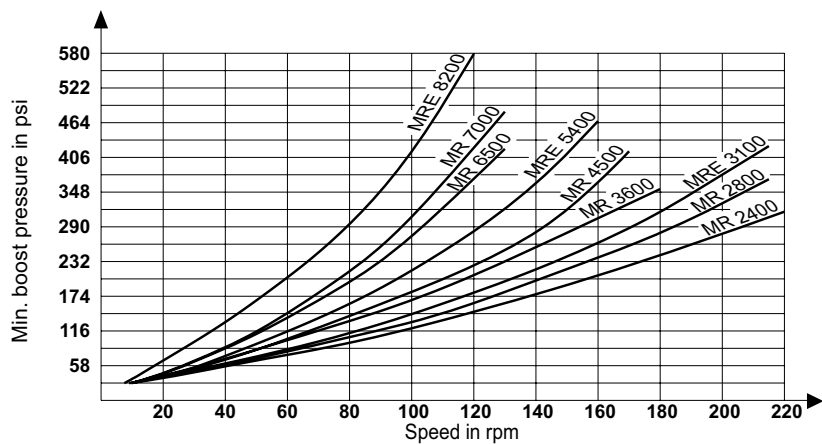

RADIAL LOAD

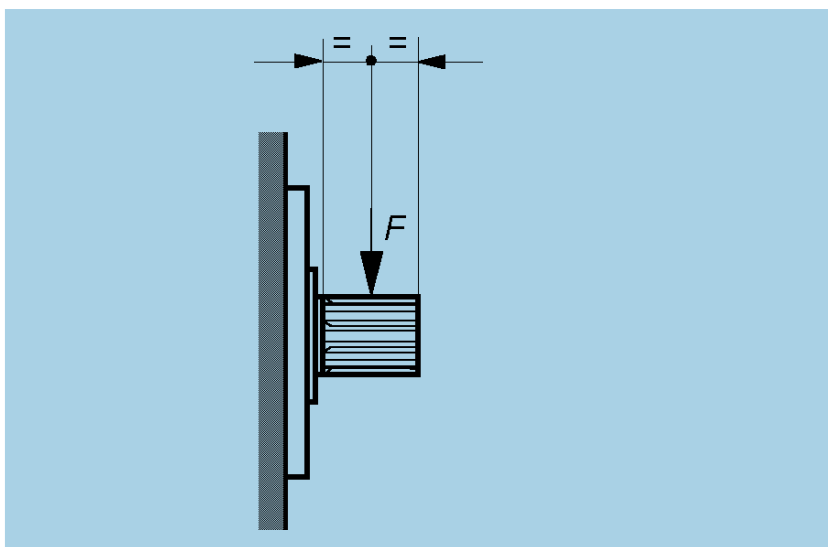

MOTOR TYPE	RADIAL FORCE _{MAX} ¹ BRIEFLY PERMITTED WITH DYNAMIC LOAD F in lbf ')	MAX. PERMITTED RADIAL FORCE IN SHAFT CENTRE BASED ON L _{H10} 5000 HOURS			speed in rpm
		INPUT PRESSURE 2901 psi F in lbf	INPUT PRESSURE 2176 psi F in lbf	INPUT PRESSURE 1450 psi F in lbf	
MR 33	4271.37	2135.69	2293.05	2382.98	400
MR 57	4271.37	2135.69	2293.05	2382.98	400
MR 73	5058.20	2023.28	2607.78	3034.92	350
MR 93	5058.20	2023.28	2607.78	3034.92	350
MR 110	5058.20	2023.28	2607.78	3034.92	350
MR 125	5058.20	1124.05	2225.61	2900.04	275
MR 160	5058.20	1124.05	2225.61	2900.04	275
MR 190	5058.20	1124.05	2225.61	2900.04	275
MR 200 *	-	-	-	-	-
MR 250	6294.65	1258.93	2225.61	2832.59	250
MR 300	6294.65	1258.93	2225.61	2832.59	250
MR 350	7868.31	3259.73	4136.49	4765.95	225
MR 450	7868.31	3259.73	4136.49	4765.95	225
MR 600	9666.78	3372.13	5058.20	6137.28	200
MR 700	9666.78	3372.13	5058.20	6137.28	200
MR 1100	12139.7	4158.97	6407.06	7913.28	150
MR 1600	15287	5889.99	9127.24	11240.45	125
MR 1800	15287	5889.99	9127.24	11240.45	125
MR 2400	19108.76	11262.93	14837.39	17265.33	110
MR 2800	19108.76	12139.68	15511.82	17849.83	100
MR 3600	24279.37	12364.50	20232.8	23155.32	100
MR 4500	24279.37	17535.1	21806.47	24504.17	85
MR 6500	30124.4	16635.86	27651.5	31698.06	50
MR 7000	30124.4	16635.86	27651.5	31698.06	50
MRE 330	6294.65	1011.64	1910.88	2675.23	250
MRE 500	7868.31	2787.63	3889.20	4676.03	225
MRE 800	9666.78	1910.87	4451.22	5912.48	200
MRE 1400	12139.7	1933.35	5395.42	7553.58	140
MRE 2100	15287	2810.11	8003.20	10858.27	120
MRE 3100	19108.76	10116.4	14500.18	17445.17	100
MRE 5400	24279.37	14162.96	20277.77	24122	80
MRE 8200	30124.4	15287.01	24728.98	28775.54	50

¹) in accordance with the dynamic condition, higher values can be accepted - MR 200* only code "F1"

BEARING LIFE

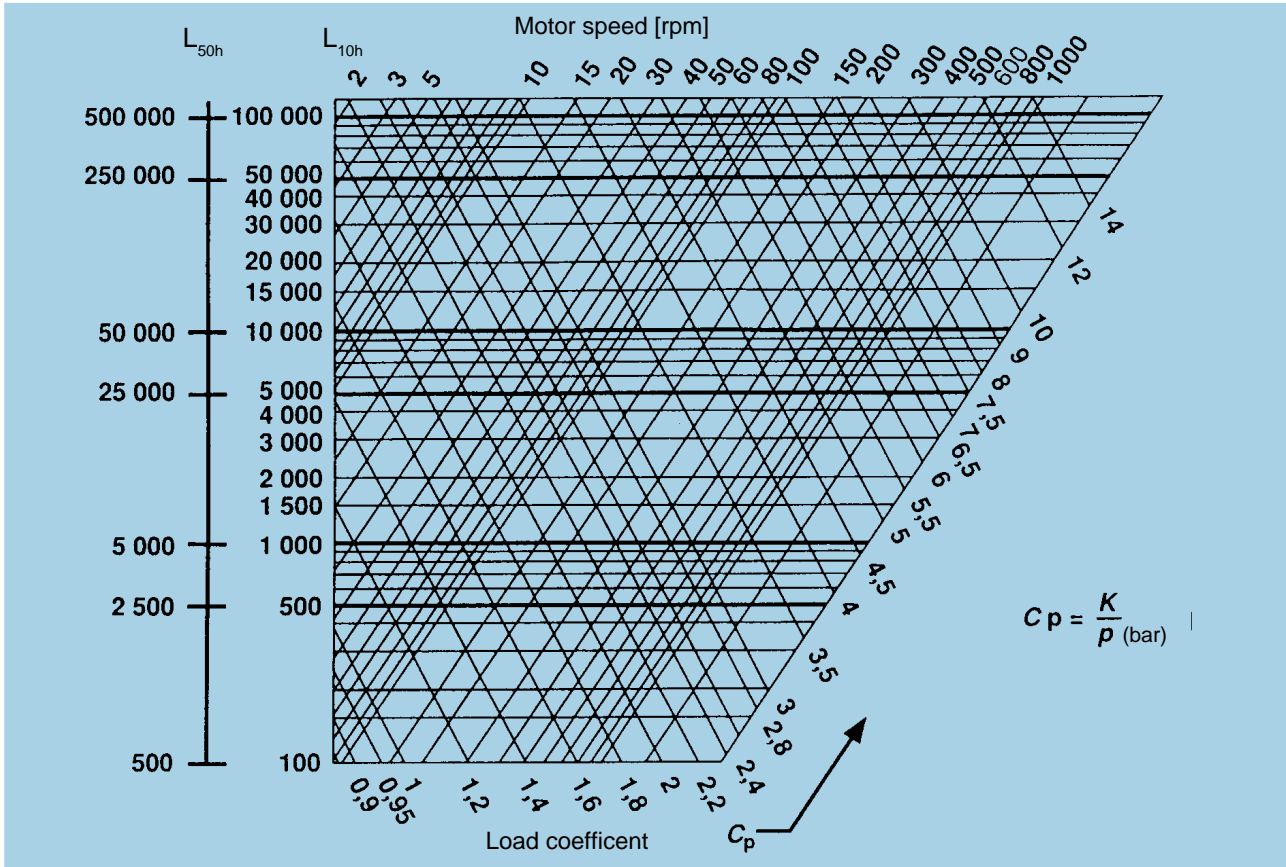

C_p = Load coefficient
 K = Service life coefficient for standard bearing
 p = operating pressure in bar
 Convert pressure 1psi = 0.0690 bar

L_{10h} is the theoretically service life value normally reached or exceeded by the 90% of the bearings.

50 % of the bearings reach the value $L_{50h} = 5$ times L_{10h} .

MOTOR TYPE	K	MOTOR TYPE	K	MOTOR TYPE	K
MR 33	2150	MRE 330	850	MRE 2100	722
MR 57	2150	MR 350	1126	MR 2400	924
MR 73	1320	MR 450	1126	MR 2800	924
MR 93	1320	MRE 500	1021	MRE 3100	828
MR 110	1320	MR 600	920	MR 3600	709
MR 125	950	MR 700	920	MR 4500	709
MR 160	950	MRE 800	808	MRE 5400	591
MR 190	950	MR 1100	844	MR 6500	710
MR 200	950	MRE 1400	693	MR 7000	710
MR 250	950	MR 1600	835	MRE 8200	550
MR 300	950	MR 1800	835		

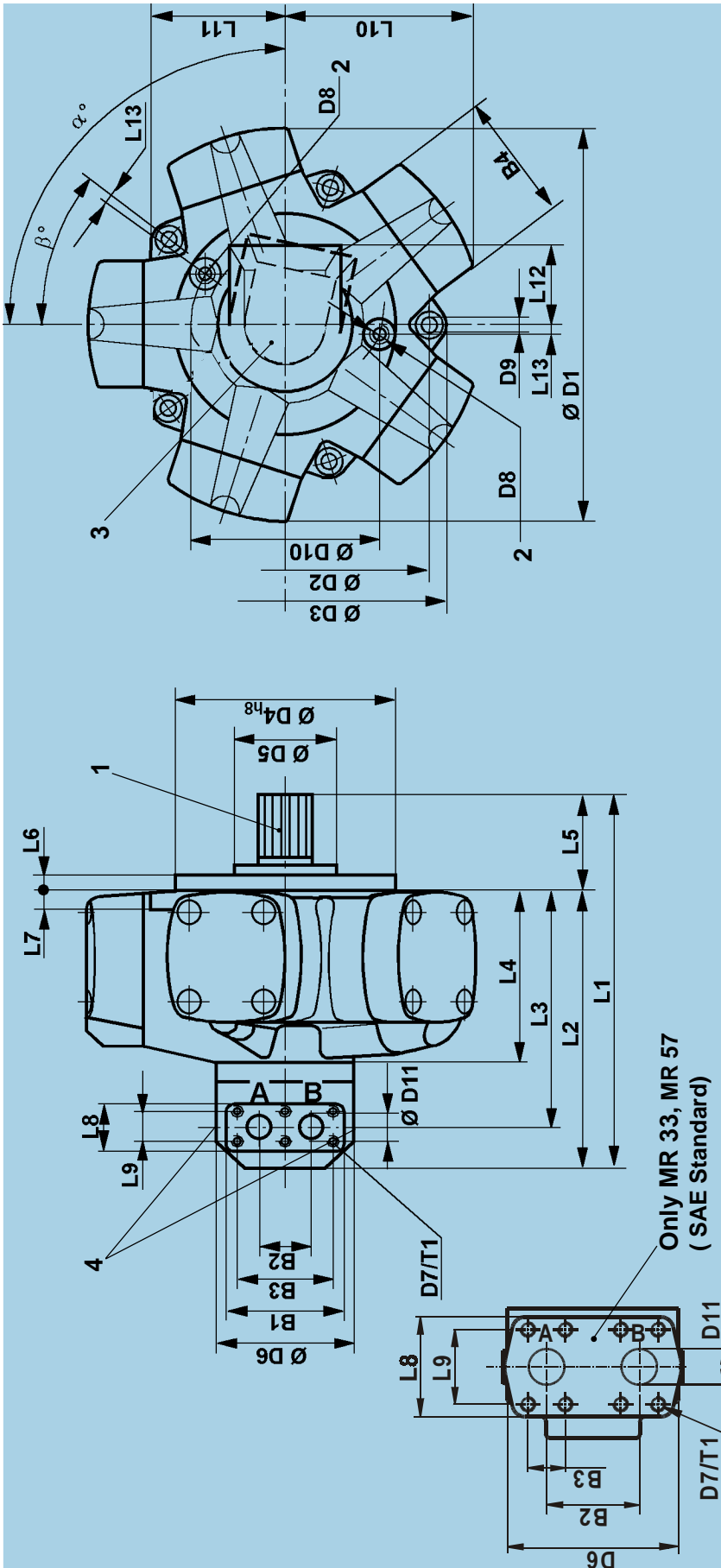

Dir. of Rotation (Viewed on shaft end)	Port inlet	ordering code (see page 35)
clockwise	A	"N"
anti-clockwise	B	"S"
clockwise	B	"S"
anti-clockwise	A	"S"

- 3 On request the port flange can be rotated by 72° (For MR 33, MR 57, MR 73, MR 93, MR 110, MR 125, MR 160, MR 190, MR 200, MR 250, MR 300, MRE 330, MR 350, MR 450, MRE 500, MR 600, MR 700, MRE 800 can be rotated by 36°) For standard position see angle α .
- 4 Port 1/4" BSP threads to ISO 228/1 for pressure reading.

- 1 Splined shaft with flank contact (for dimension see page 26) Ordering code "N1" (for further shaft ends see page 26 - 27)
- 2 Case drain port BSP threads to ISO 228/1

MOTOR DIMENSIONS - MOTOR TYPE MR - MRE

MOTOR TYPE	L1 (in)	L2 (in)	L3 (in)	L4 (in)	L5 (in)	L6 (in)	L7 (in)	L8 (in)	L9 (in)	L10 (in)	L11 (in)	L12 (in)	L13 (in)	B1 (in)	B2 (in)	B3 (in)	B4 (in)	Ø D1 (in)	Ø D2 (in)	Ø D3 (in)	Ø D4 ¹⁶ (in)	Ø D5 (in)	Ø D6 (in)	D7 (mm)	T1 (in)	D8 (in)	D9 (in)	Ø D10 (in)	Ø D11 (in)	α	β
MR 33 MR 57	9.97	7.72	5.83	4.21	2.25	0.55	0.75	2.76	2.06	4.34	3.09	2.76	0.78	4.88	2.56	1.03	2.73	9.27	6.3	7.09	4.9212 4.9188 (125 mm)	-	4.72	M10	0.98	G1/4	0.35	3.82	0.98	108°	36°
MR 73 MR 93 MR 110	11.69	9.00	7.50	5.18	2.70	0.67	0.79	2.13	1.34	4.72	3.70	2.84	-	4.72	1.97	3.94	3.54	9.84	8.03	8.84	5.7086 5.7062 (145 mm)	-	5.08	M8	0.59	G3/8	0.43	-	0.79	90°	36°
MR 125 MR 160 MR 190	12.17	9.53	8.03	5.71	2.64	0.55	0.63	2.13	1.34	5.81	4.06	2.84	0.26	4.72	1.97	3.94	3.94	12.33	8.86	9.80	6.2991 6.2967 (160 mm)	-	5.08	M8	0.59	G 3/8	0.43	6.30	0.79	90°	36°
MR 200 MR 250 MR 300 MRE 330	12.72	9.53	8.03	5.71	3.19	0.59	0.63	2.13	1.34	6.04	4.69	2.84	0.30	4.72	1.97	3.94	3.94	12.91	9.13	10.08	6.8897 6.8873 (175 mm)	3.54	5.08	M8	0.59	G 3/8	0.43	6.38	0.79	90°	36°
MR 350 MR 450 MRE 500	14.8	10.98	9.25	6.57	3.82	0.59	0.71	2.77	1.57	6.87	5.12	3.31	0.37	5.59	2.36	4.72	4.69	14.49	10.47	11.65	7.4802 7.4775 (190 mm)	3.78	6.14	M10	0.71	G 3/8	0.51	7.64	0.98	90°	36°
MR 600 MR 700 MRE 800	15.75	11.77	10.04	7.36	3.98	0.59	0.79	2.77	1.57	7.56	5.63	3.31	0.31	5.59	2.36	4.72	5.24	15.95	11.42	12.60	8.6614 8.6586 (220 mm)	4.02	6.14	M10	0.71	G 3/8	0.51	8.15	0.98	90°	36°
MR 1100 MRE 1400	18.03	13.43	11.54	7.99	4.61	0.79	0.87	3.23	1.97	8.78	6.50	4.13	0.35	6.38	2.87	5.35	5.83	18.50	12.99	14.45	9.8425 9.8397 (250 mm)	4.72	6.77	M12	0.83	G 1/2	0.59	8.98	1.22	104°	36°
MR 1600 MR 1800 MRE 2100	19.92	14.72	12.83	9.29	5.20	0.83	0.94	3.23	1.97	10.39	7.76	4.13	0.43	6.38	2.87	5.35	6.61	21.97	14.96	16.65	11.4173 11.4141 (290 mm)	5.83	6.77	M12	0.83	G 1/2	0.67	10.47	1.22	90°	36°
MR 2400 MR 2800 MRE 3100	24.37	18.35	15.43	11.22	6.02	0.94	1.02	3.86	2.44	11.93	8.70	4.84	0.59	8.19	3.39	7.09	7.48	25.28	17.32	19.45	13.1889 13.1854 (335 mm)	5.51	8.46	M14	1.10	G 1/2	0.75	12.36	1.46	90°	36°
MR 3600 MR 4500 MRE 5400	27.54	19.27	16.48	12.11	8.27	1.34	1.10	3.86	2.68	14.15	9.72	5.51	0.75	9.06	4.57	7.87	9.45	30.16	21.26	23.50	15.7479 15.7457 (400 mm) * D4 ¹⁷	-	8.46	M16	1.26	G 1/2	0.91	14.96	1.50	108°	36°
MR 6500 MR 7000 MRE 8200	31.34	22.28	19.49	15.12	9.06	1.46	1.18	3.86	2.68	16.04	9.72	5.51	0.83	9.06	4.57	7.87	10.39	34.02	23.62	25.93	17.7165 17.714 (450 mm) * D4 ¹⁷	7.48	8.46	M16	1.25	G 1/2	0.98	17.72	1.50	108°	36°

Code D 1 - DIN 5480 - (Standard)

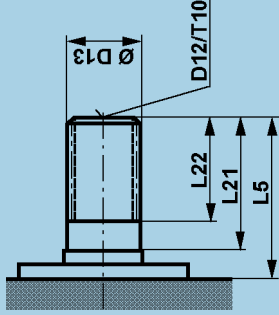

Code B 1 - BS 3550 - ()

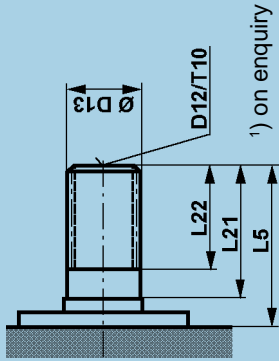

Code N 1 (Standard)

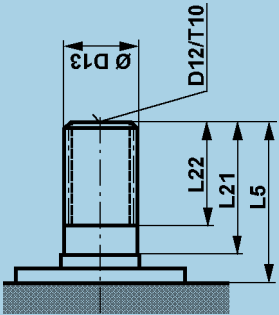

Version	N1					B1					D1								
	Type	L5 (in)	L21 (in)	L22 (in)	D12 (mm)	T10 (in)	ØD13 ex DIN 5463 (mm)	L5 (in)	L21 (in)	L22 (in)	D12 (mm)	T10 (in)	ØD13 BS 3550	L5 (in)	L21 (in)	L22 (in)	D12 (mm)	T10 (in)	ØD13 DIN 5480 (mm)
MR 33		2.24	1.57	1.10	-	-	B6x26x32	-	-	-	-	-	-	2.24	1.57	1.10	-	-	W32x1.5x20-8e
MR 57		2.70	2.03	1.24	M12	-	B6x28x34	-	-	-	-	-	-	2.70	2.03	1.24	M12	-	W35x2x16-8e
MR 93		2.64	1.97	1.40	M12	0.79	B8x32x38	2.64	1.97	1.40	M12	0.79	12/24-17	2.64	1.97	1.40	M12	0.79	W38x2x18-8e
MR 125		-	-	-	-	-	-	-	-	-	-	-	-	-	-	-	-	-	-
MR 160		3.19	2.36	1.81	M12	0.98	B8x42x48	3.19	2.36	1.77	M12	0.98	12/24-21	3.19	2.36	1.81	M12	0.98	W48x2x22-8e
MR 200 *		3.82	2.91	2.22	M12	0.98	B8x46x54	3.82	2.91	2.40	M12	0.98	8/16-17	3.82	2.91	2.36	M12	0.98	W55x3x17-8e
MR 250		3.98	3.07	2.44	M12	0.98	B8x52x60	3.98	3.07	2.44	M12	0.98	8/16-17	3.98	3.07	2.44	M12	0.98	W60x3x18-8e
MR 300		4.61	3.46	2.72	M12	0.98	B8x62x72	4.61	3.46	2.64	M12	0.98	6/12-14	4.61	3.46	2.83	M12	0.98	W70x3x22-8e
MR 350		5.20	3.94	3.11	M12	0.98	B10x72x82	5.20	3.94	2.99	M12	0.98	6/12-20	5.20	3.94	3.15	M12	0.98	W80x3x25-8e
MR 400		6.02	4.72	3.90	M12	0.98	B10x82x92	6.02	4.72	2.99	M12	0.98	6/12-20	6.02	4.72	3.94	M12	0.98	W90x4x21-8e
MR 450		8.27	6.81	5.67	M12	0.98	B10x102x112	8.27	6.81	5.61	M12	0.98	6/12-20	8.27	6.81	5.67	M12	0.98	W110x4x26-8e
MR 500		9.06	7.40	5.91	M12	0.98	B10x112x125	9.06	7.40	6.02	M12	0.98	6/12-26	9.06	7.40	6.02	M12	0.98	W120x4x28-8e

NOTE: the threaded holes (D12/T10) for the shaft versions "N1", "B1" and "D1" must be considered as service holes. In case the holes dimensions required by the application are different from the ones listed here above, please contact DENISON Calzoni.
MR_200 * only code "F1"

Code F 1 - DIN 5480 -

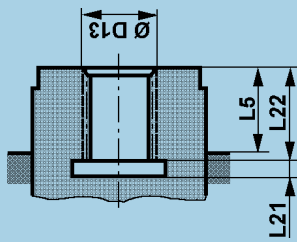

Code P 1

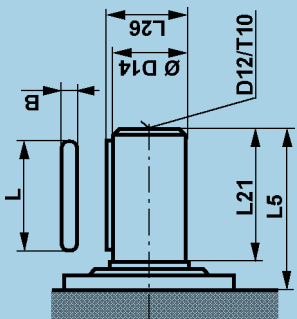

Code P 1 ***

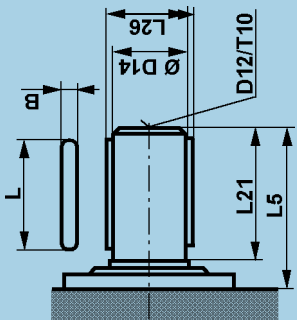

Only MR 6500, MR 7000, MRE 8200

Version	F						P						Transmitted torque (lbf.ft)
	L5 (in)	L21 (in)	L22 (in)	Ø D13 DIN 5480 (mm)	L5 (in)	L21 (in)	L26 (in)	D12 (mm)	T10 (in)	Ø D14 _{kg} (in)	Key (mm) L x B		
MR 33	0.67	0.20	0.83	N28x1,25x21-9H	-	-	-	-	-	-	-	-	-
MR 57	0.67	0.20	1.02	N32x2x14-9H	-	-	-	-	-	-	-	-	-
MR 73	0.55	0.20	1.10	N35x2x16-9H	2.64	1.97	1.69	M12	0.79	1.5755 1.5749 (40 mm)	45 x 12	366	
MR 125	1.06	0.20	1.42	N40x2x18-9H	-	-	-	-	-	-	-	-	-
MR 200 *	1.06	0.20	1.42	N40x2x18-9H	3.19	2.36	2.11	M12	0.98	1.9692 1.9686 (50 mm)	56 x 14	662	
MR 250	1.10	0.20	1.50	N47x2x22-9H	3.82	2.91	2.32	M12	0.98	2.1661 2.1655 (55 mm)	70 x 16	1042	
MR 350	1.10	0.20	1.73	N55x3x17-9H	3.98	3.07	2.52	M12	0.98	2.3630 2.3623 (60 mm)	70 x 18	1498	
MR 450	1.50	0.31	1.97	N65x3x20-9H	4.61	3.46	3.01	M12	0.98	2.7567 2.7560 (70 mm)	80 x 20	1984	
MR 600	1.85	0.31	2.24	N75x3x24-9H	5.20	3.94	3.35	M12	0.98	3.1504 3.1497 (80 mm)	90 x 22	2965	
MR 700	1.89	0.31	2.44	N85x3x27-9H	6.02	4.72	3.74	M12	0.98	3.5442 3.5434 (90 mm)	110 x 25	4578	
MR 800	1.97	0.55	2.68	N100x3x32-9H	8.27	6.81	4.57	M12	0.98	4.3316 4.3308 (110 mm)	160 x 28	7934	
MR 1600	1.97	0.55	2.99	N110x3x35-9H	9.06	7.40	5.43 ***	M12	0.98	4.8716 4.8691 (124 mm)	N°2-180 x 32	20850	

NOTE
For higher values of the torque to be transmitted, please consult DENISON Calzoni

NOTE: the threaded holes (D12/T10) for the shaft versions "P1" must be considered as service holes. In case the holes dimensions required by the application are different from the ones listed here above, please contact DENISON Calzoni.

** ØD14_{kg} for MR 6500, MR 7000, MRE 8200
*** This dimension includes two keys

MECHANICAL
TACHOMETER DRIVE

TACHOGENERATOR
DRIVE

ENCODER
DRIVE

Dimensions in inch (threaded holes in mm)

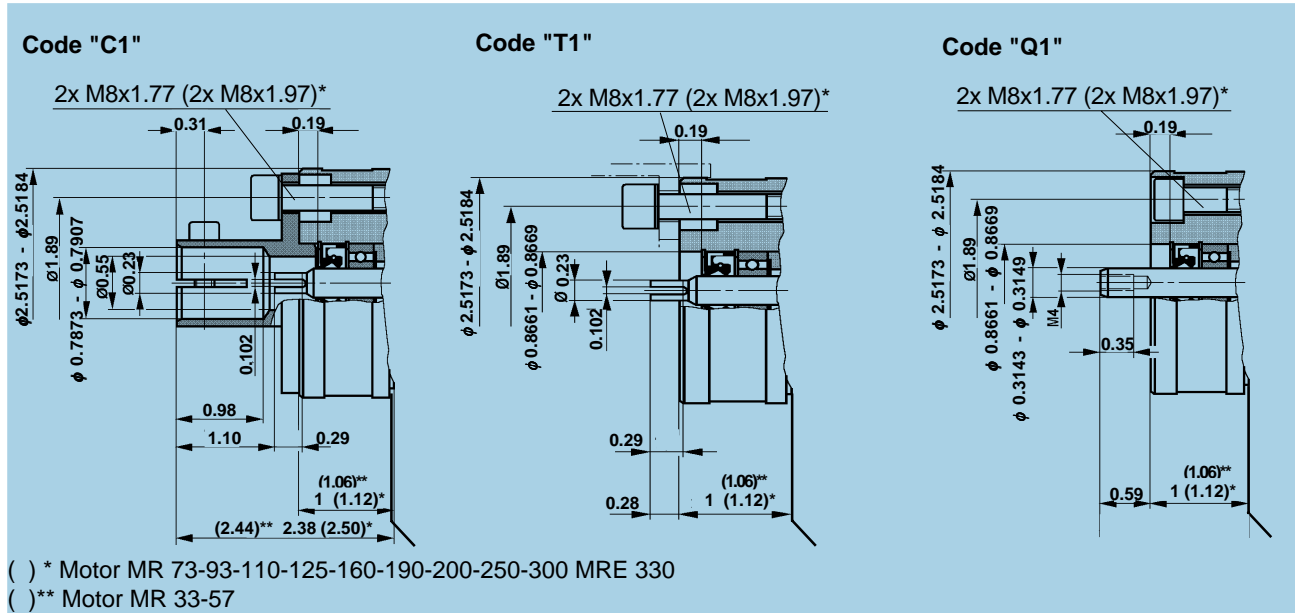

INCREMENTAL ENCODER
DIMENSIONS

Dimensions in inch (in)

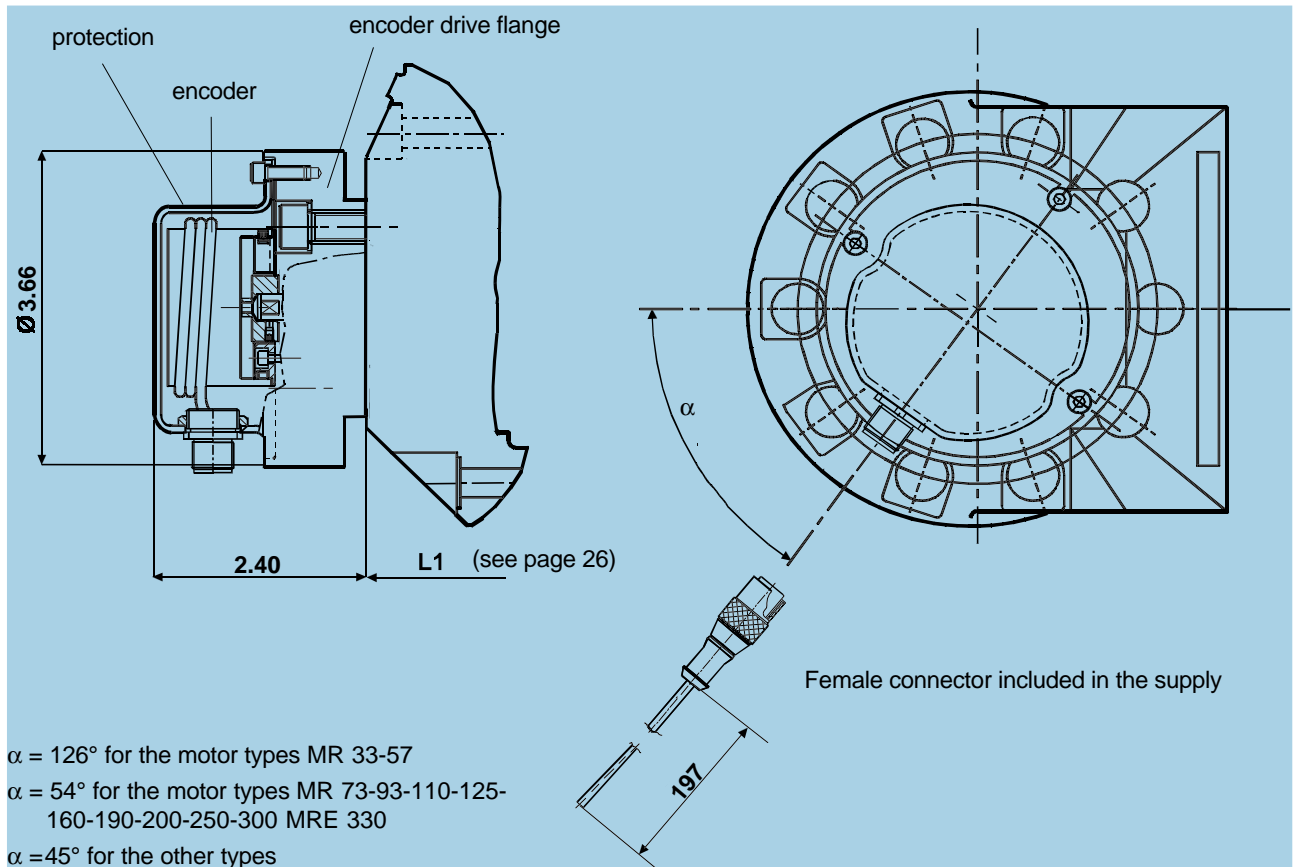

**INCREMENTAL ENCODER
CONNECTION DIAGRAMS**

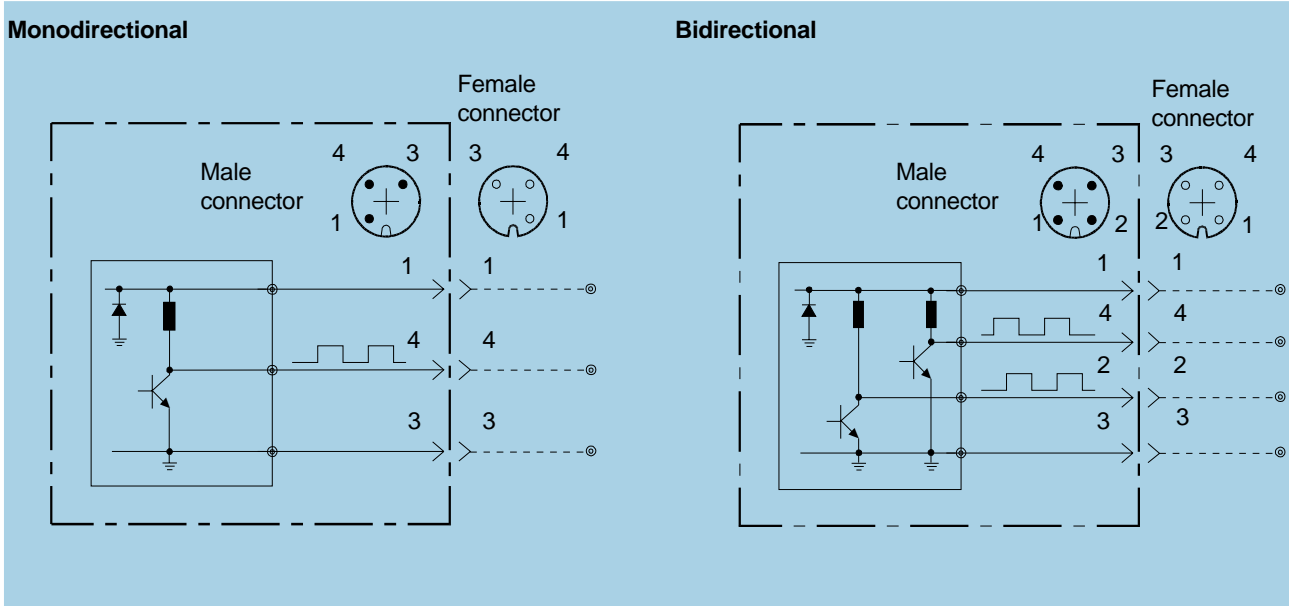

Color wires and function		
1	Brown	Power Supply (8 to 24 Vdc)
2	White	Output B phase (MAX 10 mA - 24 Vcc)
3	Blue	Power Supply (0 Vdc)
4	Black	Output A phase (MAX 10 mA - 24 Vcc)

**INCREMENTAL ENCODER
TECHNICAL DATA**

Encoder type:	ELCIS mod. 478
Supply voltage:	8 to 24 Vcc
Current consumption:	120 mA max
Current output:	10 mA max
Output signal:	A phase- MONODIRECTIONAL A and B phase BIDIRECTIONAL
Response frequency:	100 KHz max
Number of pulses:	500 (others on request - max 2540)
Slew speed:	Always compatible with maximum motor speed
Operating temperature range:	from 32 to 158 °F
Storage temperature range:	from -22 to +185 °F
Ball bearing life:	1.5x10 ⁹ rpm
Weighth:	0,220 lb
Protection degree:	IP 67 (with protection and connector assembled)

Connectors:		
MONODIRECTIONAL	RSF3/0.5 M (Lumberg)	male
	RKT3-06/5m (Lumberg)	female
BIDIRECTIONAL	RSF4/0.5 M (Lumberg)	male
	RKT4-07/5m (Lumberg)	female

Note: Female connectors cable length equal to 16.4 foot (ft).

STANDARD CONNECTION FLANGE

Code "C1"

Flange is supplied complete with screws and seals.

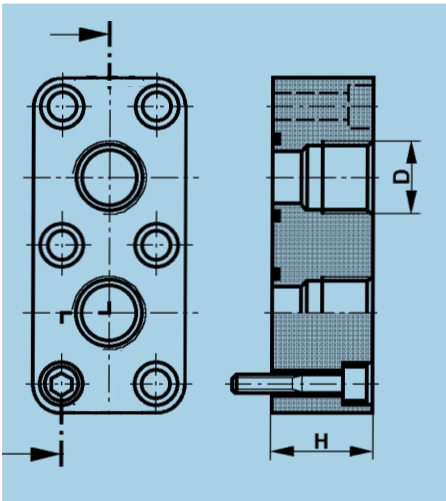

MR MRE	D (BSP)	H (inch)	CODE NBR	CODE FPM
73 - 93 - 110 125 - 160 -190 200 - 250 300 - 330	3/4"	1.42	262 098	229 394
350 - 450 500 600 - 700 800	1 1/4"	1.57	262 089	229 395
1100 - 1400 1600 - 1800 2100	1 1/2"	1.77	262 093	229 396
2400 - 2800 3100	1 1/2"	2.36	264 572	229 397
3600 - 4500 5400 6500 - 7000 8200	2"	2.36	272 724	229 398

BSP threads to ISO 228/1

Permitted up to 6000 PSI

SAE CONNECTION FLANGE

Codice "S1"

Codice "T1"

Codice "G1"

Codice "L1"

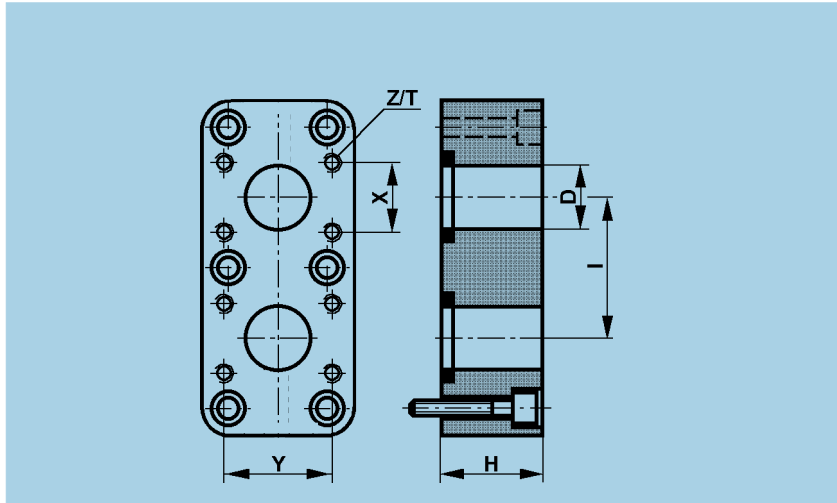

Flange is supplied complete with screws and seals. FPM seals enquiry.

MR MRE	SAE PSI	D		H (inch)	I (inch)	X (inch)	Y (inch)	METRIC		UNC		
		"	(inch)					Z (mm) T(inch)	Denison Calzoni part N° NBR	Z (")	T(inc- h)	Denison Calzoni part N° NBR
73 - 93 - 110 125 - 160 -190 200 - 250 300 - 330	5000	3/4"	0.748 (19 mm)	1.42	2.17	0.87	1.87	M10/0.98	277 295	3/8"-16	0.984	223 335
350 - 450 500 600 - 700 800	5000	1"	0.984 (25 mm)	1.57	2.36	1.03	2.06	M10/0.98	277 297	3/8"- 16	0.984	223 336
1100 - 1400 1800 - 1600 2100	4000	1 1/4"	1.220 (31 mm)	1.77	2.95	1.19	2.31	M10/0.98	277 299	7/16-14	1.18	223 337
	6000	1"	0.984 (25 mm)	1.77	2.80	1.09	2.25	M12/0.87	230 166	7/1614	1.18	342 092
2400 - 2800 3100	3000	1 1/2"	1.457 (37 mm)	2.36	3.39	1.41	2.75	M12/1.18	277 301	1/2"- 13	1.18	223 338
	6000	1 1/2"	1.457 (37 mm)	2.36	3.84	1.44	3.13	M16/1.18	230 168	5/8"-11	1.37	349068
3600 - 4500 5400 6500 - 7000 8200	3000	2"	1.969 (50 mm)	2.36	4.41	1.69	3.06	M12/1.18	277 303	1/2"-13	1.18	223 339
	6000	2"	1.969 (50 mm)	2.36	4.57	1.75	3.81	M20/1.38	230 170	3/4"- 10	1.49	342 547

COUPLINGS

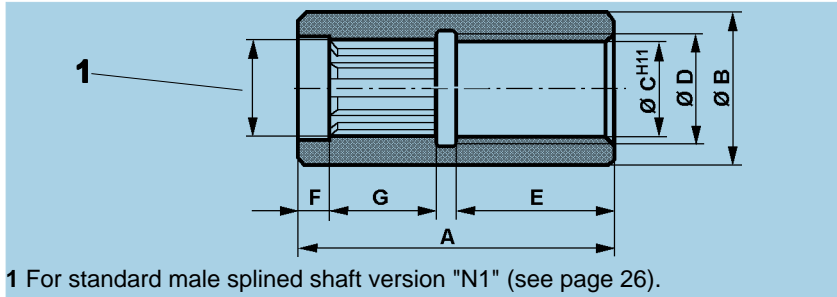

MR MRE	ORDERING CODE	A (inch)	B (inch)	CH1 (inch)	D (inch)	E (inch)	F (inch)	G (inch)
125 - 160 190	465 203	4.49	2.20	1.5417 1.5354 (39 mm)	1.85	2.13	0.61	1.36
250 - 300 330	465 202	5.31	2.80	1.9354 1.9291 (49 mm)	2.36	2.52	0.59	1.77
350 - 450 500	465 201	6.10	3.15	2.1728 2.1653 (55 mm)	2.68	2.68	0.73	2.19
600 - 700 800	465 200	6.73	3.54	2.4090 2.4016 (61 mm)	2.95	3.15	0.75	2.32
1100 1400	464 785	7.32	4.17	2.8814 2.8740 (73 mm)	3.48	3.37	0.79	2.58
1600 - 1800 2100	465199	8.82	4.65	3.2763 3.2677 (83 mm)	3.86	4.21	0.87	3.07
2400 - 2800 3100	465 198	10.43	5.20	3.6700 3.6614 (93 mm)	4.41	5	0.91	3.82
3600 - 4500 5400	474 692	13.98	5.91	4.4574 4.4488 (113 mm)	4.96	6.50	1.18	5.51
6500 - 7000 8200	422 544	15.35	7.68	4.9704 4.9606 (126 mm)	5.51	7.28	1.50	5.79

ADAPTERS WITH KEY

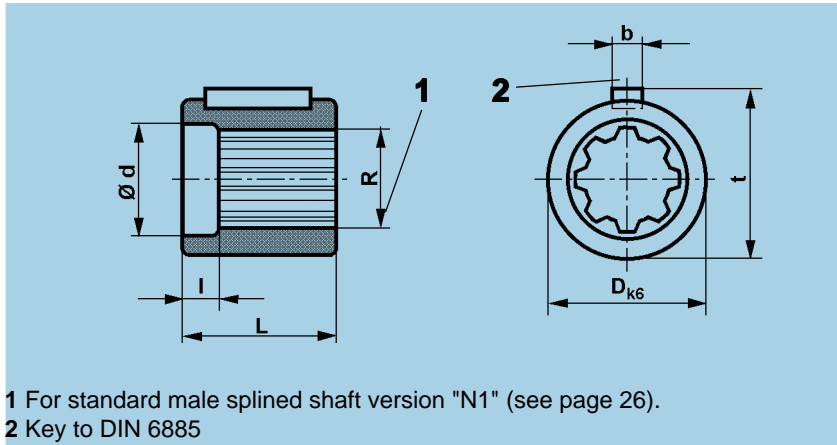

MR MRE	ORDERING CODE	R EX DIN 5463 (mm)	d (inch)	l (inch)	D _{k6} (inch)	L (inch)	b (inch)	t (inch)	Key (mm) DIN 6885
125 - 160 190	271 117	A8x32x38	1.508	0.61	2.2842 2.2835 (58 mm)	1.97	0.39	2.40	10x8x45
250 - 300 330	271 118	A8x42x48	1.902	0.59	2.7567 2.7560 (70 mm)	2.36	0.55	2.89	14x9x56
350 - 450 500	271 119	A8x46x54	2.138	0.73	3.1504 3.1497 (80 mm)	2.95	0.63	3.31	16x10x70
600 - 700 800	271 120	A8x52x60	2.374	0.75	3.5442 3.5434 (90 mm)	3.15	0.71	3.70	18x11x70
1100 - 1400	271 121	A8x62x72	2.846	0.79	4.1348 4.1340 (105mm)	3.54	0.79	4.311	20x12x90
1600 - 1800 2100	271 122	A10x72x82	3.24	0.87	4.6466 4.6457 (118mm)	4.65	0.87	4.84	22x14x110
2400 - 2800 3100	271 123	A10x82x92	3.634	0.91	5.1191 5.1182 (130mm)	5.83	0.98	5.32	25x14x140
3600 - 4500 5400	272 719	A10x102x112	4.421	1.18	6.3002 6.2993 (160mm)	7.40	1.10	6.54	28x16x180
6500 - 7000 8200	223 476	A10x112x125	4.944	1.50	7.2847 7.2836 (185mm)	7.40	1.77	7.68	45x25x180

HOLDING BRAKE UNIT DIMENSIONS - MOTOR TYPE MR - MRE

BRAKE TYPE	B 190	B 300	B 450	B 700	B 1100	B 1800	B 2800
MOTOR TYPE MR - MRE	125 - 160 190	250 - 300 330	350 - 450 500	600 - 700 800	1100 - 1400	1600 - 1800 2100	2400 - 2800 3100

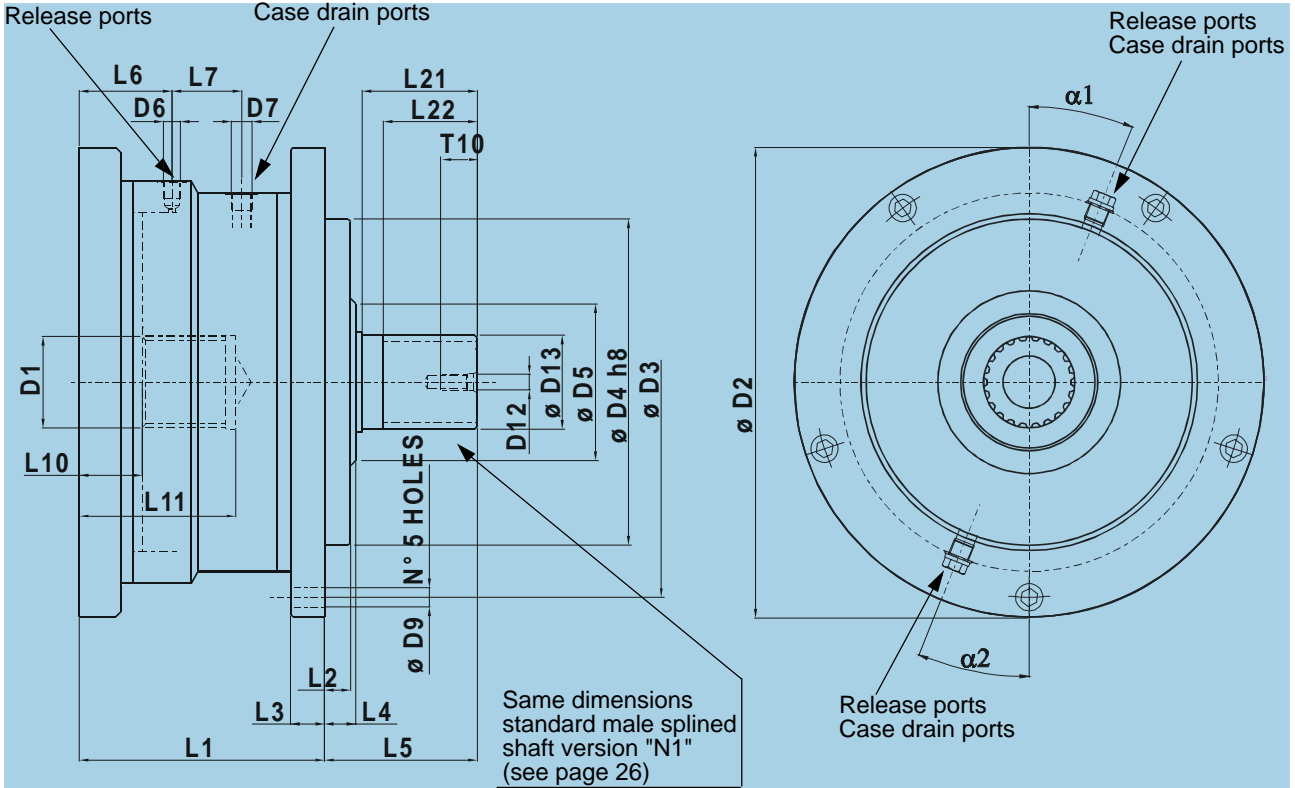

$\alpha 1, \alpha 2$ Corresponding angles to the release ports 1 and 2, to case the drain ports 1 and 2

BRAKE TYPE	L1 (inch)	L2 (inch)	L3 (inch)	L4 (inch)	L5 (inch)	L6 (inch)	L7 (inch)	L10 (inch)	L11 (inch)	L21 (inch)	L22 (inch)	D1 (mm)	D2 (inch)	D3 (inch)	D4 _{h8} (inch)	D5 (inch)	D6 (BSP)	D7 (BSP)	D9 (inch)	D12 (inch)	D13 (mm)	T10 (inch)	$\alpha 1$	$\alpha 2$
B 190	4.76	-	0.87	0.55	2.64	1.61	1.15	0.79	2.84	1.97	1.40	N 38x 2x18-9H DIN 5480	9.84	8.86	6.2991 6.2967 (160 mm)	-	1/4"	3/8"	0.41	M12	B 8x32x38 ex DIN 5463	1.10	22°30'	22°30'
B 300	5.35	-	0.98	0.59	3.19	1.65	1.56	0.83	3.39	2.36	1.81	N 48x2x22-9H DIN 5480	10.08	9.13	6.8897 6.8872 (175 mm)	-	1/4"	3/8"	0.41	M12	B 8x42x48 ex DIN 5463	1.10	22°30'	22°30'
B 450	5.79	-	1.06	0.59	3.82	1.95	1.42	0.95	3.94	2.91	2.22	N 55x3x17-9H DIN 5480	11.65	10.47	7.4802 7.4774 (190 mm)	-	1/4"	3/8"	0.53	M12	B 8x46x54 ex DIN 5463	1.10	22°30'	22°30'
B 700	6.77	-	1.10	0.59	3.98	2.17	1.81	0.98	4.13	3.07	2.44	N 60x3x18-9H DIN 5480	12.60	11.42	8.6613 8.6585 (220 mm)	-	1/4"	3/8"	0.53	M12	B 8x52x60 ex DIN 5463	1.10	22°30'	22°30'
B 1100	7.40	0.79	1.02	0.95	4.61	2.80	2.11	1.89	4.72	3.47	2.84	N 70x3x22-9H DIN 5480	14.17	12.99	9.8424 9.8396 (250 mm)	4.72	1/4"	M16x- 1.5	0.59	M12	B 8x62x72 ex DIN 5463	1.10	0°	0°
B 1800	8.50	-	1.10	0.83	5.20	2.50	2.30	1.34	5.32	3.94	3.11	N 80x3x25-9H DIN 5480	16.65	14.96	11.4172 11.4141 (290 mm)	-	1/4"	1/2"	0.69	M12	B 10x72x82 ex DIN 5463	1.10	22°30'	22°30'
B 2800	10.35	-	1.18	0.95	6.02	3.43	2.64	1.67	6.50	4.72	3.90	N 90x4x21-9H DIN 5480	19.45	17.32	13.1889 13.1854 (335 mm)	-	1/4"	2"	0.75	M12	B 10x82x92 ex DIN 5463	1.10	22°30'	22°30'

TECHNICAL DATA

(For operation outside these parameters, please consult **PARKER Calzoni**)

CHARACTERISTICS		BRAKE TYPE						
		B 190	B 300	B 450	B 700	B 1100	B 1800	B 2800
STATIC BRAKING TORQUE	lbf.ft	922	1328	1955	2950	4573	8408	12612
DYNAMIC BRAKING TORQUE	lbf.ft	642	885	1069	1623	3098	4610	8851
RELEASE PRESSURE	psi	406	406	392	392	392	435	435
MAX. OPERATING PRESSURE	psi	6092	6092	6092	6092	6092	6092	6092
MOMENT OF INERTIA OF ROTATING PARTS	lbf.ft ²	0.112	0.147	0.688	1.020	1.448	4.746	6.407
WEIGHT	lb	70.5	86	119	163	220,5	348.5	577.5
MOTOR TYPE MR MRE		125 160 190	250 300 330	350 450 500	600 700 800	1100 1400	1600 1800 2100	2400 2800 3100

CODE

Example: BRAKE - B 450 - N1 V1 **

1. BRAKE - B 450 NI V1 **

BRAKE TYPE

B 190	Brake for motor size "C"
B 300	Brake for motor size "D"
B 450	Brake for motor size "E"
B 700	Brake for motor size "F"
B 1100	Brake for motor size "G"
B 1800	Brake for motor size "H"
B 2800	Brake for motor size "I"

2. BRAKE - B 450 - N1 V1 **

SHAFT

N1	Spline ex DIN 5463 (see page 26)
D1 *	Spline DIN 5480 (see page 26)
F1 *	Female spline DIN 5480 (see page 27)
* please contact DENISON Calzoni	

3. BRAKE - B 450 - N1 V1 **

SEALS

N1	NBR: mineral oil
V1 *	FPM seals
U1	No shaft seal (for brake)
* please contact DENISON Calzoni	

4. BRAKE - B 450 - N1 V1 **

SPECIAL

**	Space reserved to Denison Calzoni
-----------	-----------------------------------

Mounting

Any mounting position

- Note the position of the case drain port (see below)

Install the motor properly

- Mounting surface must be flat and resistant to bending

Min. tensile strength of mounting screws to DIN 267 Part 3 class 10.9

- Note the prescribed fastening torque

Pipes, pipe connections

Use suitable screws!

- Depending on type of motor use either threaded or flange connection

Choose pipes and hoses suitable for the installation

- Please note manufacturing data!

Before operation fill with hydraulic fluid

- Use the prescribed filter!

NOTE: Two of the mounting screws must be precisely located/fitted if operation is started and stopped frequently or if high reversible frequencies exist.

Coupling

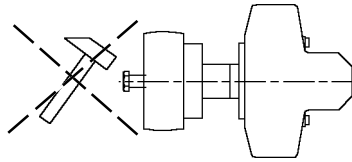

- Mounting with screws
- Use threaded bore in the drive shaft
- Take apart with extractor

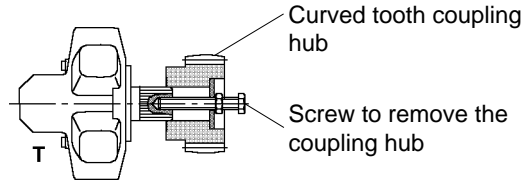

Curved tooth coupling hub

Screw to remove the coupling hub

DRAIN AND FLUSHING LINK INSTALLATION EXAMPLES

Note: Position the case drain pipe, so that the motor **cannot run empty**.

T = Seal
 Y = Motor housing feeding line
 ← = Bleed

Installation instructions for motors of the series "MR - MRE"

Low pressure case drain returns to tank.

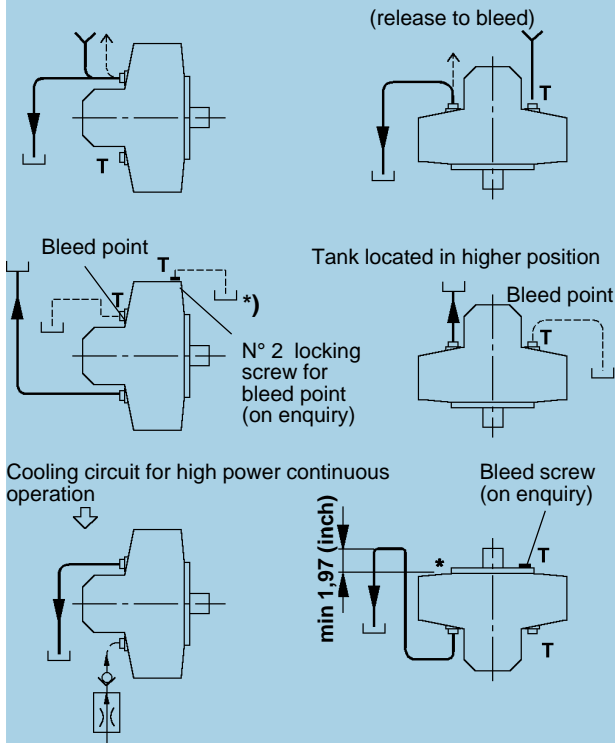

Installation instructions for motors of the series "MR - MRE with brakes"

Low pressure case drain returns to tank.

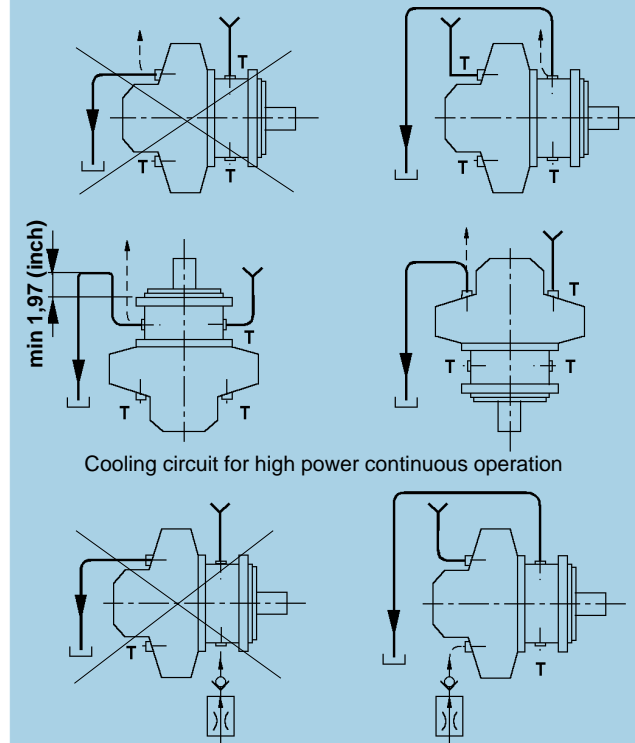

*) Special designs for applications, where the equipment needs to be filled with oil.(e.g. in a salty atmosphere)

Motors without shaft seal used with brake

CODE

Example: MR 160C - N1 M1 F1 N1 N **

1. MR 160C - N1 M1 F1 N1 N **
SERIES

MR	standard 3626 psi max. continuous
MRE	expanded 3046 psi max. continuous

2. MR 160C - N1 M1 F1 N1 N **

SIZE & DISPLACEMENT

A	code	MR 33 A	MR 57 A		
	in ³	1.96	3.44		
B	code	MR 73 B	MR 93 B	MR110 B	
	in ³	4.43	5.65	6.65	
C	code	MR 125 C	MR 160 C	MR 190 C	
	in ³	7.61	9.75	11.69	
D	code	MR 200 D	MR 250 D	MR 300 D	MRE 330 D
	in ³	12.16	15.31	18.56	20.28
E	code	MR 350 E	MR 450 E	MRE 500 E	
	in ³	21.33	27.56	30.38	
F	code	MR 600 F	MR 700 F	MRE 800 F	
	in ³	37.10	43.09	49.08	
G	code	MR 1100 G	MRE 1400 G		
	in ³	68.7	83.6		
H	code	MR 1600 H	MR 1800 H	MRE 2100 H	
	in ³	97.5	110.4	127.6	
I	code	MR 2400 I	MR 2800 I	MRE 3100 I	
	in ³	139.9	170.4	189.4	
L	code	MR 3600 L	MR 4500 L	MRE 5400 L	
	in ³	221.9	274.8	329.6	
M	code	MR 6500 M	MR 7000 M	MRE 8200 M	
	in ³	394.2	408.7	502	

3. MR 160C - N1 M1 F1 N1 N **

SHAFT

N1	spline ex DIN 5463 (see page 26)
D1	spline DIN 5480 (see page 26)
F1	female spline DIN 5480 (see page 27)
P1	shaft with key (see page 27)
B1	spline B.S. 3550 (see page 26)

4. MR 160C - N1 M1 F1 N1 N **

SPEED SENSOR OPTION

N1	none	
Q1	encoder drive (see page 28)	
C1	mechanical tachometer drive (see page 28)	
T1	tachogenerator drive (see page 28)	
M1	incremental Elcis encoder	Uni-directional
B1	(500 pulse/rev) (see page 28)	Bi-directional

5. MR 160C - N1 M1 F1 N1 N **

SEALS

N1	NBR mineral oil
F1	NBR, 218 psi shaft seal
V1	FPM seals
U1	no shaft seal (for brake)

6. MR 160C - N1 M1 F1 N1 N **

CONNECTION FLANGE

N1	none
C1	standard DENISON Calzoni (see page 30)
S1	standard SAE metric (see page 30)
T1	standard SAE UNC (see page 30)
G1	SAE 6000 psi metric (see page 30)
L1	SAE 6000 psi UNC (see page 30)

7. MR 160C - N1 M1 F1 N1 N **
ROTATION

N	standard rotation (CW: inlet in A, CCW: inlet in B)
S	reversed rotation (CW: inlet in B, CCW: inlet in A)

8. MR 160C - N1 M1 F1 N1 N **
SPECIAL

**	space reserved to Denison Calzoni
-----------	-----------------------------------